



PORTAGANTRY® 1100-6600

➤ Assembly & Operation Guide

> Contents

Correct Operation	4	ATEX	12
Intended Use		ATEX	
Maximum Capacity		Classification [Zone 2]	
Inspection Prior to Initial Operation		Classification [Zone 1]	
Inspection Before Starting Work		Spark Formation	
Temperature Range		Static Electricity	
Notes for Correct Operation		Inspection, Maintenance & Repair	
Warning			
Traversing the Load		Assembly Instructions	14
Moving Under Load		Variants & Options	19
Fall Protection Applications	8	Dimensions	25
Use as a Fall Protection Anchor		Quality & Safety	28
Additional Notes for Correct Operation		Regulations	
Warning		Accreditations	
IRATA		Conformité Européenne [CE] & UK Conformity Assessed [UKCA]	
Inspection & Maintenance	11	Testing	
Regular Inspections		Language	
Maintenance & Repair		Product IPR	
Storage & Transportation		Product Labelling	30
		Inspection Record	31

Lightweight. Portable. **Safe.**

Please read the following instructions and guidance notes carefully, before using or operating the system.

They contain important information about how to handle and use the system in a safe and efficient way, avoiding danger, reducing repair costs and downtime, and increasing the reliability and lifespan of the system.

They apply for:

- Operation, including preparation, troubleshooting during operation and cleaning
- Maintenance, inspection and repair
- Transportation

It is the responsibility of the end user to adhere to the Health & Safety and accident prevention standards and legislation valid in their respective countries and any regions in which the system is being used. A rescue plan also needs to be in place in the event of an emergency that could occur during the work. This document should form part of the overriding Risk Assessment and Method Statement required for each lift.

➤ Correct Operation

Intended Use

This product is designed, tested and intended to be used for the lifting of goods, the lifting of personnel or for providing a safety anchor for the prevention of falls as part of a personal fall protection system. (PFAS). The use of our products for these multiple applications is consistent with the products design, notwithstanding pre-user inspections and mandatory inspections by a competent or qualified person, determined by local regulations.

Inspection Prior to Initial Operation

Each product must be inspected prior to initial operation by a competent person to ensure that the structure is safe and that it has not been damaged by incorrect assembly, transport or storage.

Inspection Before Starting Work

Before starting work, the product assembly and all load-bearing components should be checked for visual defects. This includes checking the integrity of all profiles for denting, making sure there is no wear or elongation on the bolt holes and ensuring that the trolley moves freely along the beam.

Maximum Capacity

Lifting of Goods: Each product will be marked with a Capacity. The capacity is specifically intended as a maximum limit for the lifting of goods, materials and equipment and includes safety factors. When using modular gantries, due to the interchangeability of A-frames and beams to suit the customers need,

the lowest rated element of the gantry always takes precedent. A-frames are independently marked with a capacity for safety.

Lifting of Personnel: For the lifting of personnel REID Lifting will reduce the capacity by half, thereby increasing the safety factor of the product. As for lifting goods, materials and equipment, the lowest rated element of the gantry always takes precedent. Associated equipment used for lifting personnel must be rated accordingly. It is the employers' responsibility to ensure this is the case. For example, a winch must be personnel rated and where necessary, meet applicable standards and regulations for the country of use.

Fall Protection Anchor: In most cases (subject to labelling and instructions for use for specific products confirming this) REID lifting products are tested and meet the requirements of fall protection standards and regulations, including ANSI Z359.18-2017 and various OSHA Regulations as referenced in our Instructions for Use. The capacity on the beam or A-frame is of no relevance to fall protection standards and requirements and the user should refer to the specific sections of the instructions for use, for detailed information. For example, ANSI requires that anchors that form part of a personal fall protection system are capable of withstanding a 5000lb static load (22.2kN) for a single user, 7500lb (33.3kN) for two users and 10,000lb (44.4kN) for three users and so on. OSHA

requires a minimum safety factor of 2, validated by a qualified person. REID Lifting products will, where applicable be marked with the rating for fall protection. Safety factors will be higher than those for lifting and forces will be limited by the use of personal fall protection equipment, including load limiting devices such as shock absorbers or self-retracting lifelines that reduce impact forces, typically between 4kN and 8kN per user as required by law.

Note: some jurisdictions may not allow the same equipment to be used for lifting of materials and as a component of a PFAS. Some employers may also prefer to keep such equipment distinctly separate. If this is the case, we would recommend that the equipment is labelled accordingly.

Check your local regulations before putting equipment to use and designate accordingly.

It is expected that all users of this product have the necessary medical and physical capabilities, are fully trained and deemed competent in its safe assembly and use. We would remind users of the requirement to ensure that work is properly planned, risk assessments carried out and as required, method statements for carrying out work provided.

Where required the owner/user of the equipment should ensure that a qualified person has been consulted in respect of the need for structural

validation, for example (but not limited to); calculating imposed loads for the safety of ground, floor or roof structures during lifting operations.

This product has different ratings depending upon the application as detailed in the table below:

Application	Capacity			
Goods Lifting [lb]	1100	2200	4400	6600
Personnel Lifting [lb]	550	1100	2200	3300

For fall protection applications see page 7.

Temperature Range

This product can be operated in ambient dry temperatures between -10°F to 131°F (-23° to +55°C). Consult your supplier in case of extreme working conditions.

Notes for Correct Operation

- We recommend the use of load-sensing or overload protection devices on all lifts
- The risk assessment and method statement must take into account any factors that might apply additional loading to the product during lifting operations
- Suitable, appropriately rated winches and connection plates must be used for all applications

- Take care when transporting and storing the product to avoid damage
- Assemble only as instructed (ensure all bolts are present and fitted correctly as per instructions)
- We recommend that appropriate PPE is worn when using the equipment
- The product should be set up at a safe distance from the hazard or lift area, before moving the structure into place
- The beam must be horizontal prior to any lift and a-frames vertical and parallel to each other
- Do not use the product if the trolley does not run freely along the beam. (for certain applications, such as when the product is being used as a restraint point, the trolleys can be locked into position)
- Attach the hoist to the lifting point on the trolley only, making sure it is attached in a way that does not expose the user to danger by the hoist, chain or load
- Do not allow the load to swing
- When lifting, keep the load low to the ground
- Only raise and lower loads when castor brakes are engaged
- To avoid side pull, lowering and lifting should only be carried out when the load chain forms a straight and vertical line between the load

and lifting attachment point on the trolley. If a vertical line is not possible you must ensure that the load is within the footprint of the Gantry A-frames (refer to figure A).

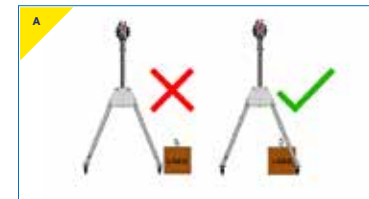

- To ensure stability of the structure, the operating span of the beam (C) must be equal to or greater than the distance between the castors on the A-Frame (G)
- The supporting ground/structure where the product is to be used must be stable and capable of withstanding the maximum expected load applied during use

Warning

- The equipment should not be used outside of its limitations, or for any purpose other than that for which it is intended
- When winching, only use one winch with each sheave and make sure they never cross paths with each other
- Do not lift or transport loads while personnel

➤ Correct Operation

are in the danger zone

- Do not allow personnel to pass under a suspended load
- Never leave a suspended load unattended
- It is not recommended to mix the use of the gantry with personnel and goods lifting simultaneously.
- Do not start moving the load along the beam until you have checked that it has been attached correctly
- When moving a loaded trolley along the beam, move the load steadily and in a controlled manner and avoid sudden movements
- Be aware of hazards when setting up/folding down, such as trapping fingers in rotating parts
- Be aware of any adverse weather conditions such as strong or gusty winds which could impose additional horizontal loads and affect the stability of the structure. Stop using if weather is impacting on lifting, and either disassemble the gantry or tie it to a rigid structure to ensure it can't overturn
- Don't allow the load to hit the product frame

Traversing the Load

Due to a high modulus of elasticity in aluminum, when loaded the gantry beams will deflect. This is perfectly normal for our products. Using aluminum enables us to achieve the highest levels of strength to weight ratio, which is an important feature of portable gantries. The level of deflection will be determined by the span length and the beam profile that is being used, as well as the weight of the load being lifted.

Before traversing loads on the **PORTAGANTRY**, it is important to take in to account the following;

- Only use appropriate REID trolleys to move the load on the beam.
- When moving a loaded trolley along the beam, move the load steadily and in a controlled manner. Do not apply an excessive force to try and move the load if it does not move easily.
- Depending upon the beam section (A, B or D), beams will deflect when loaded. **This is normal.** The greater the load, the greater the deflection. Please refer to our beam deflection table for more information. Deflection must be taken into consideration when planning the lift.
- Any traversing of loads along the beam must be performed in a controlled manner to ensure complete stability of the structure throughout the operation.

- Deflection of the **PORTAGANTRY** can be reduced (or limited) by increasing or down rating its capacity by 50%. Increasing the beam section can also help limit deflection. Please contact REID for further advice.
- Another safe recommendation for moving the load along the beam is to use a mechanical aid. REID Lifting can supply you with our geared Trolleys, rope control systems or shackled cheek plates can be fitted. The rope control system is particularly useful on longer beams or where the gantry is at maximum height of lift.
- Using a mechanical aid such as a geared trolley, chain hoist in conjunction with shackled cheek plates or rope control system for traversing the load helps optimize the gantry capacity.

The Trolley Rope Control system has the added advantage of enabling the operator to control the movement of the trolley from a safe location at the side of the gantry. The system includes a winch and series of sheaves that produce a mechanical advantage and reduce the effort during operation.

For guidance we recommend the maximum loads that can be safely moved with standard trolleys without a mechanical aid (subject to all other site conditions being taken into consideration in a risk/hazard analysis) are:

- A section beams up to 15' < 1100lb or 50% capacity of the gantry whichever is lower.
- B section beams up to 18' < 1100lb or 50% capacity of the gantry whichever is lower.
- D section beams up to 18' < 2200lb or 50% capacity of the gantry whichever is lower.
- D section beams up to 27' < 1100lb or 50% capacity of gantry whichever is lower.

To be able to effectively and safely move loads above these limits the operator should use the most appropriate mechanical aid. For further advice, please contact REID Lifting or a qualified or competent person.

Incorrect use of the gantry could lead to accidents causing personal injury and/or damage to equipment and infrastructure.

Please ensure that the advice and guidelines in this Assembly & Operation Guide are followed.

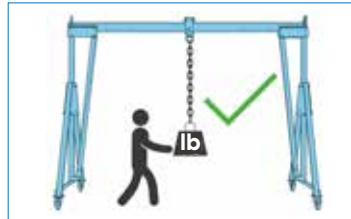

Moving Under Load

When moving the gantry under load, the following instructions **MUST** be followed:

- This product can only be moved in the direction perpendicular to the beam
- Directional locks must be used on the castors (perpendicular to the beam only)
- The end user **MUST** make sure the center of gravity of the load is known and the lifting points are in such a way that the load is **EQUALLY** distributed, so the load generates a vertical pull to the beam.
- The load is not allowed to swing
- The floor must be smooth, flat, free from cracks or steps and the weather conditions should be safe for the operation (i.e. not when frost, ice or snow present)
- A risk assessment and method statement are required to be completed by a competent person before moving the gantry under load
- The products movement must be controlled at a slow speed, no sudden movements or high speeds are allowed.

Standard Beam Length

Capacity [lb]	8' 2½"	9' 10'	12' 10¼"	15'	18' ¾"	27' 6¾"
2200	A ¾" - ¾"	A ¾" - ¾"	A ½" - ¾"	A ¾" - 1¼"	A 1¼" - 2"	B 4¾" - 4¾"
4400	A ¾" - 5/8"	A ¾" - ¾"	A 1" - 1¾"	A 1¾" - 2"	B 2½" - 2½"	D 2¾" - 3¾"
6600	A ½" - ¾"	A ¾" - 1"	B 1¾" - 1¾"	B 2½" - 2¾"	D 1½" - 1½"	D 3¾" - 4¾"
11000	D ¾" - ¾"	D ¾" - 5/8"	D ¾" - 1½"	D 1½" - 1½"	D 2" - 2½"	X

Approx Beam Deflection at Max Capacity

➤ Fall Protection Applications

Use as a Fall Protection Anchor

This section must not be read in isolation from all other sections of this manual. Read the whole manual before using this product.

Fall arrest: This product is tested and conforms to the requirements of ANSI Z359.18-2017 type D for fall arrest protection for single or multiple users depending on the configuration of the product. The Product can be used as part of a personal fall protection system that meets the requirements of ANSI Z359.18, OSHA 1910 subpart I and 1926.502 subpart M. When being used for fall arrest, the operator must use a body harness and a shock absorber that complies with the relevant national standards and regulations and that limits the maximum allowed force (MAF) to 8kN.

Users may be attached to the system via a traveling trolley (which may also be locked in place) or via a fall protection device mounted to the side cheek plate of the A frame, which is subsequently deviated through a pulley and sheave carrier. Only one person should be attached to each trolley in accordance with the notified capacity. Each personnel lift must be properly planned, and all weights clearly known along with a clear understanding of the capacity and constraints of all personal fall arrest system components.

The capabilities stated in the table below apply to standard range systems only. If unsure about your system consult serial labels, information filled in on page 27 or consult your supplier. Custom versions of the system are available tailored to specific lifting needs. These versions are designated with a 'C' at the end the product number on the serial label attached to each A-frame and beam.

This product has different ratings depending on the application as detailed in the table below:

Application	Capacity			
	1100	2200	4400	6600
Fall Arrest*	2 persons	2 persons	2 persons	2 persons

*Only Applicable to the product being used in accordance with ANSI Z359.18. The product can support more users in Fall arrest if used in accordance with OSHA 1910 Subpart I or 1926 Subpart M. Please contact REID Lifting for further details.



The system is not suitable for fall arrest applications.



The system is suitable for fall arrest applications. Specify number of users. Max weight of 330lb.

Additional Notes for Correct Operation

- The anchorage must always be above the users head to prevent dangerous free falls
- Always carry out pre-use checks before using this equipment. It is advised to use a buddy system and inspection must be by a competent person.
- The fall arrest device must only be attached to the lifting point on the trolley or the designated location on the cheek plate or upright. (see product images and set up instructions).
- Never walk away from the footprint of the product or move outside designated safe zones whilst connected to it where there is a risk of a fall (refer to figure B). Ensure that the operating area is within the footprint of the system before beginning work.



- › When using the product as a fall arrest anchor ensure there is adequate fall clearance when working at height (refer to figure C). A competent person should calculate this taking into account all of the components of the personal fall arrest system and allowing a safety margin.

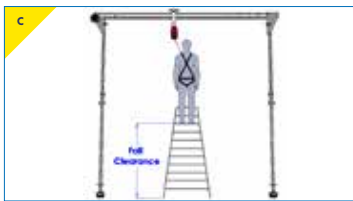

- › Only use the product for fall arrest applications when the castor brakes are engaged.
- › To ensure stability of the structure, the operating span of the beam must be equal to or greater than the distance between the castors on the A-Frames
- › Always consider the potential effects of sharp edges, chemical reagents, electrical conductivity, cutting, abrasion, climatic exposure on all components of the fall protection system, and the effect of offset forces as a result of pendulum falls.

- › Ensure the structure on which the product is mounted is horizontal. If necessary, adjust the products feet to achieve a level operating structure.
- › If the product has been subjected to a fall arrest or impact force it must be immediately removed from service.
- › The substrate of the structure on which the product is placed must be able to sustain the loads specified for the device in all orientations permitted, including a safety factor of at least 2.
- › Never exceed the number of allowable users.
- › Never adjust the product whilst a person is attached to it.
- › Only use designated anchor points for the attachment of fall protection devices
- › Ensure that any fall protection system components being used are compatible and meet the requirements of applicable standards
- › When using this equipment ensure that there is a rescue plan prior to starting work and ensure that users are trained in the correct execution of the plan and have all necessary rescue equipment to hand
- › Where required by regulation, each installation must be approved by a qualified person

- › Always wear appropriate PPE when installing, setting up, dismantling and using this equipment.
- › Misuse of this product could result in serious injury or death

➤ Fall Protection Applications

Warning

- For fall protection applications the maximum user weight is 330lb (150kg) or the weight allowed by the lowest rated piece of equipment in the fall arrest system
- Ensure that you have read and understood the maximum force tables for each anchor point
- This equipment must only be assembled, installed and used by persons who have been trained in its correct application and use
- When using for fall protection, only use one fall arrest device with each pulley/sheave and make sure that working procedures prevent individual lifelines from crossing and becoming tangled
- When using the product in conjunction with another manufacturer's fall protection products, ensure that you have read the instructions for use of those products to ensure their suitability and any restrictions for use. Only use approved brackets for the connection of winches and self-retracting lifelines

- It is essential for safety that the product is withdrawn from use immediately and not be used again until confirmed in writing by a competent person should
 1. Any doubt arises about its condition for safe use or;
 2. It has been used to arrest a fall
 3. It has been used for any other purpose, other than as a component of a personal fall protection system

IRATA [International Rope Access Trade Association]

This product is suitable for rope access and has been tested to 15kN (3300lb) static load as per test requirements of IRATA international code of practice (ICOP).

The following information is based on REID Lifting's recommendations and does not remove the responsibility of the user to comply with the relevant regulations and standards that are valid in the respective countries and regions where the system is being used.

Regular Inspections

To ensure that the product's frame remains in safe working order it must be inspected regularly by a competent or qualified person. We recommend inspections every 6 months for personnel lifting and every 12 months for goods only, unless local regulations, adverse working conditions or profile of use and risk dictate shorter periods. The components of the system need to be checked for damage, wear, corrosion or other irregularities. It may be necessary to disassemble the system in order to do this. Particular attention should be paid to checking the profiles for denting, pins and fixings for integrity, making sure there is no wear or elongation on the bolt holes and ensuring that the trolley moves freely along the beam.

It is recommended that once inspected or repaired, the device is marked with the date of the next inspection.

Inspections are instigated by the user. If detailed information is required on inspection and test criteria, please contact your supplier's technical department or REID Lifting. The equipment Inspection Record is on page 27.

If using the product in explosive atmospheres, see additional section titled ATEX.

Maintenance & Repair

In order to ensure correct operation, the conditions for inspection and maintenance must be complied with. If any defects are found, stop using the product immediately.

No alterations or additions to the equipment beyond the replacement of standard parts by an authorized representative should be made without the written consent of the manufacturer. Any necessary repairs identified during inspections should only be carried out by an approved specialist workshop using original spare parts. Any repair must be carried out in accordance with the manufacturer's instructions.

It is recommended to maintain the equipment in a clean and dry manner. Cleaning is suggested using a sponge or cloth with warm, soapy water, rinsing and allowing to dry.

This product must be assembled using metric fixings of the same type and quality as those supplied by the original manufacturer only. Failure to do so could have an impact on the structural performance and stability of the product. REID Lifting and its resellers can supply these spare parts locally.

Storage & Transportation

When transporting the components, take note of all the manual handling considerations.

Do not throw the product down or stack any items on top of it.

Always place carefully and securely on the ground to avoid damaging the equipment.

ATEX

This product has been designed for use in explosive atmospheres in line with the following requirements and information. Any use which differs or exceeds this is considered incorrect and REID Lifting Ltd will not accept any responsibility or liability for damages resulting from false application. The risk is solely with the user. If the product has been customized in any way, then it may not comply with standards and no longer be suitable for use in explosive atmospheres. If this is the case, then the product will not have any of the markings below. If in doubt, please contact your REID representative.

Classification [Zone 2]

As standard, the product meets the requirements of Category 3 equipment for use in Zone 2 explosive atmospheres, providing a normal level of protection where mixtures of air and gases, vapours or mists or by air and dusts mixtures are unlikely to occur or, if they do occur, are likely to do so only infrequently and for a short period only.

The product will have the following identification on the serial label:

As Standard for Zone 2 Environments:

 II 3 GD
 Ex h IIC T6 Gc
 Ex h IIIC T85°C Dc
 Tamb -20°C to +55°C

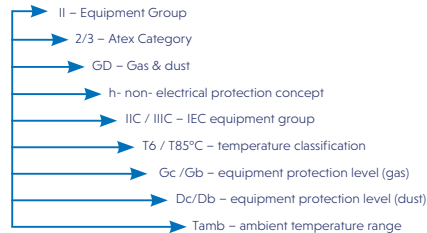

Classification [Zone 1]

Available as an upgrade, the product can be supplied to meet the requirements of Category 2 equipment for use in Zone 1 explosive atmospheres, providing a high level of protection where mixtures of air and gases, vapours, mists or by air and dusts mixtures are likely to occur.

The product will have the following identification on the serial label:

As an upgrade for use in Zone 1 environments:

 II 2 GD
 Ex h IIC T6 Gb
 Ex h IIIC T85°C Db
 Tamb -20°C to +55°C

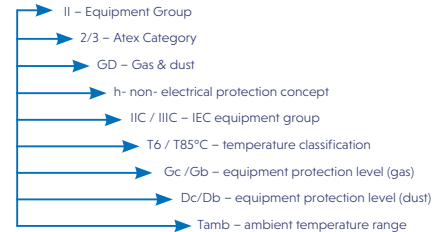

Spark Formation

There is an increased danger of ignition when certain material pairings clash, namely non-corrosion-resistant steel or cast iron against aluminum, magnesium or pertinent alloys. This applies especially in the case of rust or surface rust. When assembling the product and inserting fastening components, these must therefore be clear of rust and debris of any kind. As stated previously, care must be taken to ensure the gantry is handled in a suitable manner, never thrown down and always placed carefully onto the ground.

- For Zone 1 and 2 applications, the height of the product should not be adjusted using the ratchet mechanism and/or geared wheel within those zones
- REID recommends the use of corrosion resistant tools when assembling the product to prevent the possibility of any sparks.
- For ATEX Zone 1 use, stainless steel castor brackets are fitted to reduce the possibility of a spark.

Static Electricity

For Zone 2 applications, there is a potential risk of static electricity build-up leading to an incentive spark. Although the risk of such ignition is unlikely, the product must be earthed during assembly and use. This can be achieved by attaching an earthing lead to a convenient location on metallic parts of both the product and trolley.

For additional protection in Zone 1 applications, the product is fitted with anti-static trolley rollers, stainless steel fasteners and therefore does not need to be earthed.

However, the effectiveness of the conductivity during operation can be affected by a dirty tread or other environmental influences and therefore must be checked periodically by the operator

Inspection, Maintenance & Repair

Special attention should be given to dust deposits on the structure, especially in areas where the profiles come into contact, and should be wiped clean and care taken not to apply materials that could create electrostatic charging. Additionally, the bearings in the trolley rollers and castors should be checked to ensure they rotate freely.

The structure is predominantly constructed from aluminum which will not rust. However, there are steel components used throughout. These are; fasteners, castors, master-link, trolley rollers, A-frame height adjustment gearing product (if fitted) and the height adjustment ratchet (if fitted).

Where there is sign of any rust deposits on the aluminum structure, it should be wiped clean as above and, where there is sign of rust on a steel component, that component should be removed from use and the structure not used until a replacement is fitted.

If using the product in explosive atmospheres, in addition to the Regular Inspection and Maintenance information above, these additional instructions should be followed:

- Inspections must be instigated by the user prior to each use if used in a potentially explosive atmosphere.
- Inspections and maintenance must be carried out at a safe distance away from an explosive atmosphere.

➤ Assembly Instructions

The **PORTAGANTRY**® and its constituent components are described in the image below.

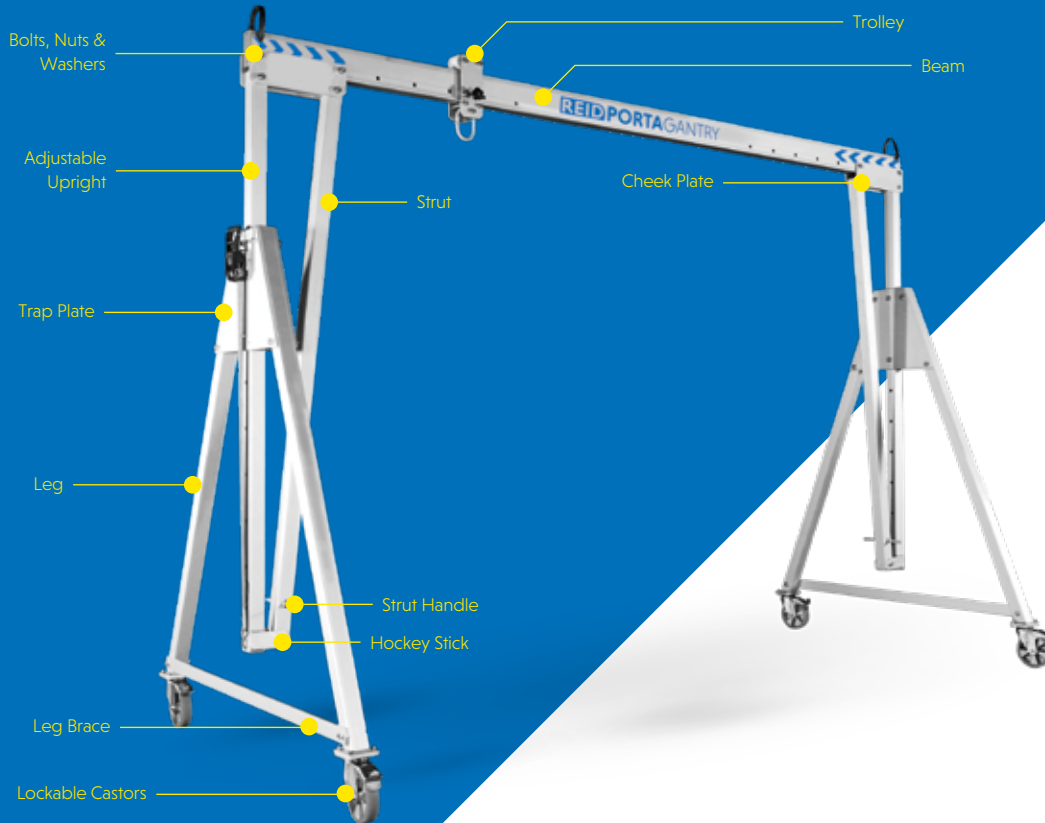

Appropriate PPE should be worn: ➤ **Gloves** ➤ **Protective Footwear** ➤ **Hard Hat**





The **PORTAGANTRY**® system is delivered flat packed on a pallet and should include:

- 2 x A-Frames
- 1 Trolley
- Beam (sometimes shipped separately)



Gantry Tool Set (supplied as an option):

- Ratchet handle 1/2" sq drive
- 24mm socket
- 24mm combination spanner
- 14mm long series allen key
- 14mm Hex key socket



This illustration demonstrates how an Aframe will arrive, prior to its assembly.



4a

Assemble each Aframe by:

- Positioning legs and bolt in place
- Attaching leg brace

The unit is most easily assembled with the Aframes at their lowest height setting and this is the recommended position to start from.

5

Lock castors in orientation shown. Do not use hands!

- Apply the castor brakes
- Put brakes on only with protective footwear ensuring that the castors are in the orientation shown

➤ Assembly Instructions

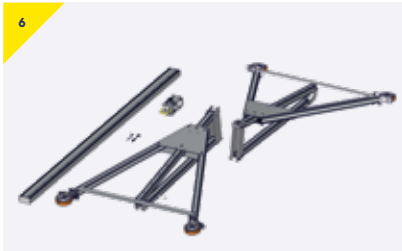

Carry out a pre-assembly visual check to ensure the following parts are included;

- Beam
- Trolley
- 2 x A-Frames
- Tool Set (Option)

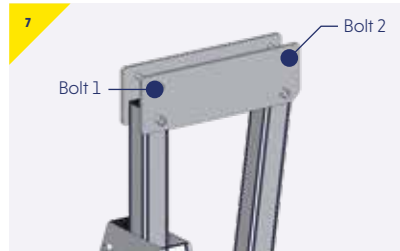

This illustration demonstrates the bolt positions (1 & 2) for the cheek plates.

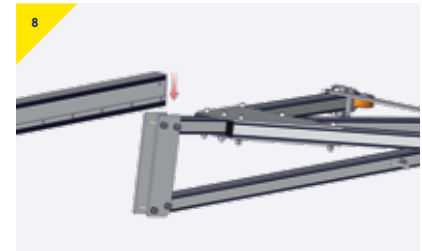

- Lay the two A-Frames a beam length apart on a flat surface in line with each other with the castor wheels outward and brakes on
- Lay the beam on the Aframes, resting on bolt 1 on each cheek plate

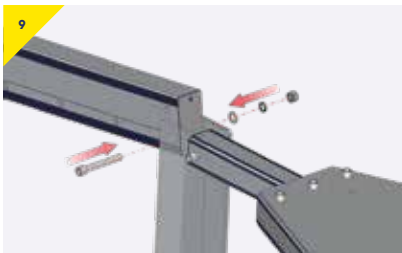

- Offer one end of the beam to the rear bolt-hole on the cheek-plate (bolt 1) and insert a bolt
- Put on plain washer, spring washer then nut, finger tight

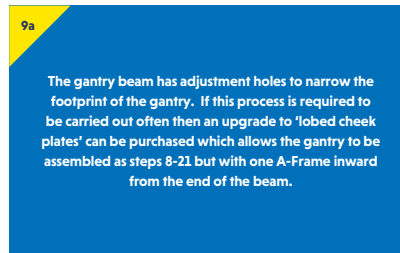

The gantry beam has adjustment holes to narrow the footprint of the gantry. If this process is required to be carried out often then an upgrade to 'lobed cheek plates' can be purchased which allows the gantry to be assembled as steps 8-21 but with one A-Frame inward from the end of the beam.

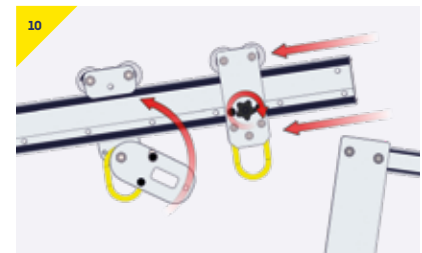

- Thread the beam trolley over the other end of the beam and lock with the friction brake at approximately centre position. If using a gated trolley, lock with the friction break

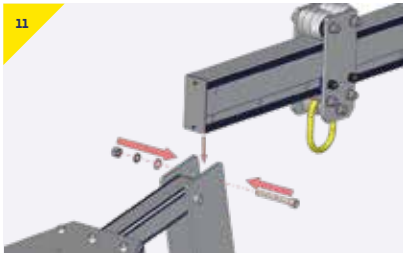

- > Offer opposite side of beam to the rear bolt-hole on the cheek-plate (bolt 1) and insert bolt
- > Put on plain washer, spring washer then nut, finger tight

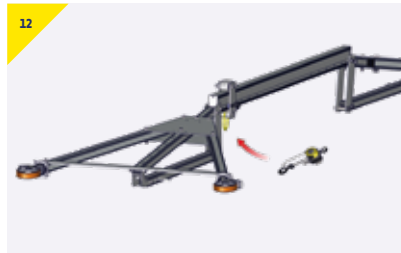

- > Attach the lifting device to the trolley in order to avoid having to lift and attach when gantry is fully erect.



Keep hands clear of potential "Pinch" area marked with warning tape, in the scissoring system. The chain hoist must be positioned at the opposite end of beam.

- > With the help of another person, scissor the beam and A-Frame into position (using the first bolt as a hinge). Be careful not to trap any fingers in this operation



- > Insert the second bolt into the cheek-plate. Tighten both bolts until spring washer is fully depressed, be cautious not to overtighten

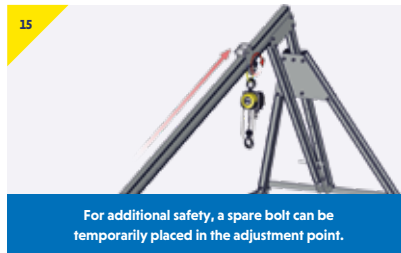

For additional safety, a spare bolt can be temporarily placed in the adjustment point.

- > Move trolley to other end of beam, opposite to the end to be raised, and secure by tightening the trolley knob



- > Repeat the scissor activity at the opposite end of the gantry

> Assembly Instructions

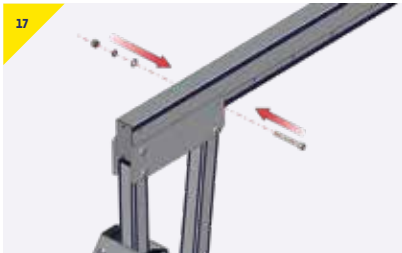

- > Insert and tighten the final beam bolt



- > If the hoist is not already attached to the suspension point on the trolley, do so now (using stepladder if height setting requires)



The gantry is now erect at its lowest height setting.



Beam height adjustment bolts (2 bolts on each upright). Tighten all bolts to 27 Nm (20 ft lbs) or until spring washers are fully depressed.

- > Decide on the height required (always using the lowest possible setting)

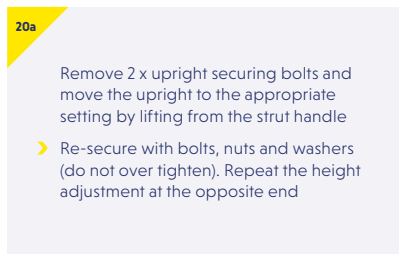

- Remove 2 x upright securing bolts and move the upright to the appropriate setting by lifting from the strut handle
- > Re-secure with bolts, nuts and washers (do not over tighten). Repeat the height adjustment at the opposite end



Ensure the beam is horizontal and castors are locked prior to any lift.

- > Release trolley and castor brakes to position the gantry over the load, ensuring if possible that the load is lifted from the center of the beam

Variants & Options.



➤ Variants & Options

The list below outlines additional variants and options available;

- Wind Up Jack Legs
- Ratchet Beam Elevation System
- Conversion to Winched Configuration
- Lobed Cheek Plates
- Shackled Cheek Plates
- Customized Configurations
- Jointed Beam Options

Wind Up Jack Leg Option (WUJL)

WUJL'S can be fitted to the gantry. This provides additional fine height adjustment (up to 10"). Each foot may be adjusted independently providing a method of levelling the system on uneven ground.

If wind up jack legs are fitted the following points must be observed:

- Check whether the castors fitted are Load Rated or Pneumatic.

N.B. For pneumatic (non load bearing) castors the WUJL system must always be applied prior to performing any lift. If load rated castors are

fitted the operator can choose whether the castors or WUJL take the load on each foot of the gantry

- When manoeuvring the gantry, always have the jack legs in the 'parked' position as shown in figure 1.
- Position the gantry for the lift before setting the height with the jack
- Before lifting ensure all jacks are in the correct lifting position and are secured with locking pins and clips as shown in figure 2
- Manually raise each leg in turn and set the height by rotating jack handle clockwise
- Having set the adjustment of all four legs, ensure that the gantry uprights are vertical, and the beam is horizontal

WUJL Inspection/Maintenance

The jack legs and brackets should be subjected to periodic inspections by a competent person in line with the products inspection and maintenance guidelines (see page 8). It is recommended that when not in use the jack legs are removed and stored in a clean and dry manner. The jack leg should be lubricated with EP2 grease on the internal thread and gears, at regular intervals (up to 6 months maximum), depending on service conditions.

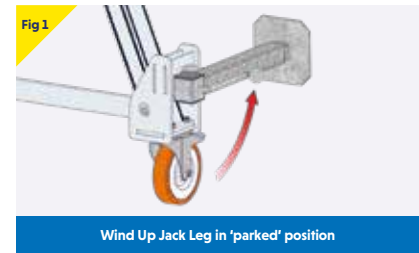

Wind Up Jack Leg in 'parked' position

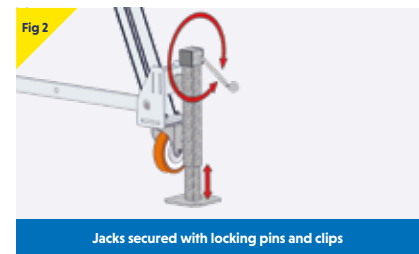

Jacks secured with locking pins and clips

Ratchet Beam Elevation System Option

(Two person operation recommended – one on each A-Frame)

Always wear gloves when using this item.

- Release Ratchet (Figure 3). Ensure the hook at the end of ratchet strap is positively engaged within the bottom hole of the A-Frame upright (Figure 4).
- Remove lower bolt on trap plate
- Tension ratchet strap to take the upright/beam weight
- Remove upper bolt on trap plate
- Operate ratchet to adjust height to required setting, ensuring that the bolt holes are aligned as in figure 5
- Re-insert upper bolt and nut/washer assembly
- Ease tensioned strap aside, re-insert lower bolt and secure.
- Repeat steps on the second A-Frame, ensuring that the gantry uprights are vertical, and the beam is horizontal
- Check all bolts on the gantry are sufficiently secure by ensuring all spring washers are fully depressed

Easy Conversion to Winched Configuration

A Winch Kit and accessories can be supplied to convert the system into a winch capable system. Please contact your REID Representative for further details and requirements.

Lobed Cheek Plates

Lobed Cheek Plates allow for ease of assembly when adjusting the operating span of the Gantry. The modified Cheek Plates allow the clear operating span to be adjusted by moving one frame in, whilst still allowing the standard assembly methods to be observed.

- When adjusting the operating span the Lobed Cheek Plate A-frame needs to be erected first when following standard assembly instructions.

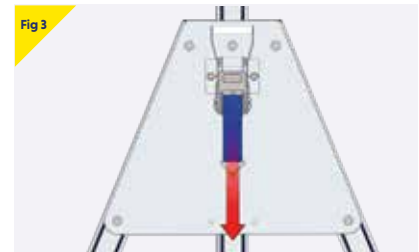

Operate Ratchet



Ratchet in 'parked' position

➤ Variants & Options

Shackled Cheek Plates

The cheek plate with shackle pull point offers a mechanical aid to move the load along the beam in a control manner.

A chain block is required for this operation with a minimum capacity of 250kg.

Notes for Correct Operation

- Ensure the chain block is attached to the shackle on the cheek plate, and on the master link of the trolley.
- The movement of the load should be from the center of the beam to the A-frame where the chain block is attached.
- The load chain will allow for the movement of the trolley, controlled by the operator using the hand chain on the block.

Customized Configurations

For customized systems additional assembly and operation information may be provided as required.

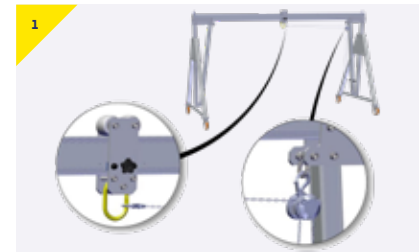

- Connect the chain block to the shackle on the cheek plate as shown
- Release the load chain until reaching the master link of the trolley, connecting the hook as shown



- Operate the chain block to move the trolley along the beam

Jointed Beam [A-Section]

The jointed beam offers an alternative option to our standard beams, the product comes in 2 parts for ease of transportation.

Jointed beams are not included in standard range. Each configuration should be assessed to determine feasibility. [Max rating is 1100lb]

Notes for Correct Operation

- Ensure all bolts in the joint are present and tightened to 27Nm [20 ft lbs].
- Avoid point loads on top of the joint.
- The joint positioning must be 2/3 of the overall length of the beam.
- Ensure the trolley runs freely over the joint before loading.



- The **PORTAGANTRY** jointed beams are delivered pre-assembled

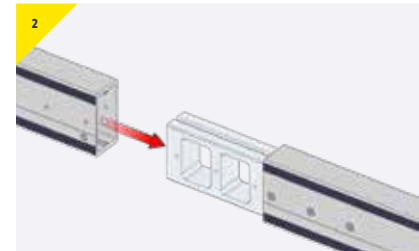

- Slide the jointed beams together, ensuring the internal guide blocks are aligned correctly

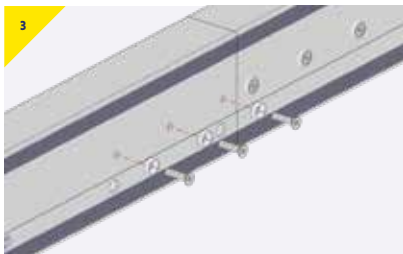

- Secure one side using the countersunk bolts & washers supplied

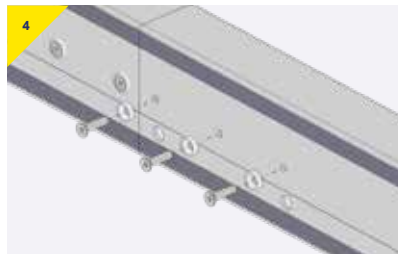

- Secure the opposite side using the countersunk bolts and washers provided



- To continue assembling the **PORTAGANTRY**, follow the instructions in the standard assembly section

➤ Variants & Options

Jointed Beam [D-Section]

The jointed beam offers an alternative option to our standard beams, the product comes in 2 parts for ease of transportation.

Jointed beams are not included in standard range. Each configuration should be assessed to determine feasibility. [Max rating is 2200lb]

Notes for Correct Operation

- Ensure all bolts in the joint are present and tightened to 27Nm [20 ft lbs].
- Avoid point loads on top of the joint.
- The joint positioning must be 2/3 of the overall length of the beam.
- Ensure the trolley runs freely over the joint before loading.



- The **PORTAGANTRY** jointed beams are delivered pre-assembled

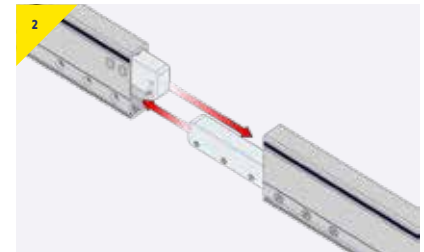

- Slide the jointed beams together, ensuring the internal guide blocks are aligned correctly

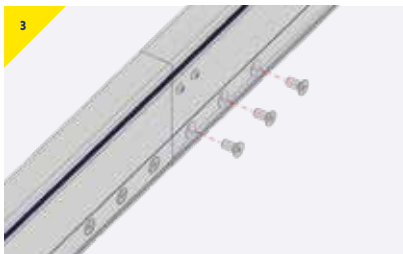

- Secure one side using the countersunk bolts & washers supplied

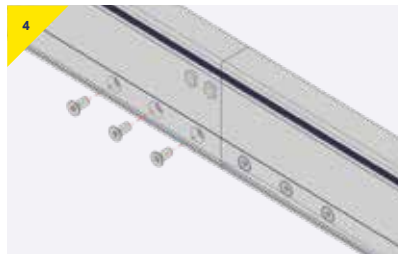

- Secure the opposite side using the countersunk bolts and washers provided



- To continue assembling the **PORTAGANTRY**, follow the instructions in the standard assembly section

PORTAGANTRY™

- A** Beam length
- B** Beam adjustment
- C** Clear operating span
- D** Height to lifting eye
- E** Height increment
- F** Height to top of beam
- G** Width
- H** Height to top of roller

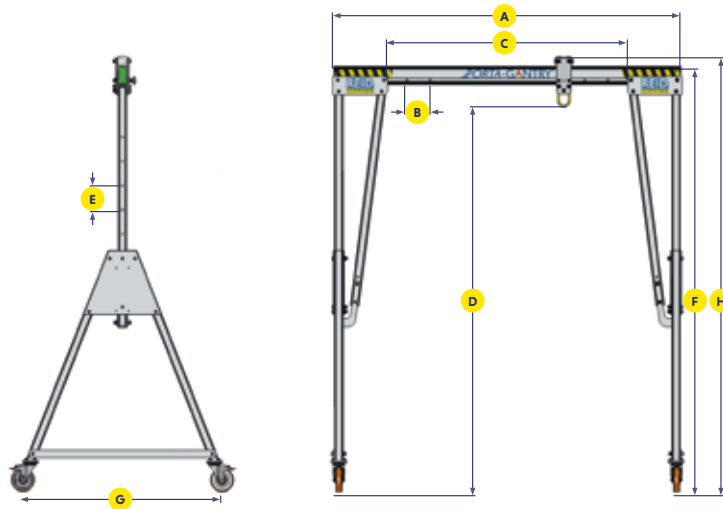

Beam Height Adjustment

The height of each gantry beam is easily adjusted by the release of 2 bolts on each upright and can be easily and safely raised into position by increments of 7" or 6" depending on product.

To assist with this activity a Ratchet system is provided for the larger gantries; manual on smaller frames.

Dimensions

		Product Code	A Beam Length	B Beam Adjustment	C Clear Operating Span	Dmax Max height to lifting eye	Dmin Min height to lifting eye	E Height increment	F Max height to top of beam	G Width	Hmax Max height to top of roller	Hmin Min height to top of roller	Fall Arrest Capacity** No. of Person(s)	Personnel Lifting [lb]	Castor Diameter	Beam Profile	Weight [lb]	
Capacity [lb]	4400	Small	US-PGSS04400S-8A	8' 2½"	4 x 8"	5' 2¼"	7' 8¾"	5' 2¾"	5 x 6"	8' 9¼"	3' 11¾"	9' ½"	6' 7"	2	2200	6"	6" x 3"	196
			US-PGSS04400S-10A	9' 10"	4 x 8"	6' 9¾"	7' 8¾"	5' 2¾"	5 x 6"	8' 9¼"	3' 11¾"	9' ½"	6' 7"	2	2200	6"	6" x 3"	203
			US-PGSS04400S-13A	12' 10¼"	6 x 8"	9' 10"	7' 8¾"	5' 2¾"	5 x 6"	8' 9¼"	3' 11¾"	9' ½"	6' 7"	2	2200	6"	6" x 3"	218
			US-PGSS04400S-15A	15'	8 x 8"	11' 11¾"	7' 8¾"	5' 2¾"	5 x 6"	8' 9¼"	3' 11¾"	9' ½"	6' 7"	2	2200	6"	6" x 3"	229
			US-PGSS04400S-18B	18' ½"	8 x 8"	15' ¼"	7' 8¾"	5' 2¾"	5 x 6"	8' 9¼"	3' 11¾"	9' ½"	6' 7"	2	2200	6"	6" x 3"	269
			US-PGSS04400S-27D	27' 6¾"	8 x 8"	24' 6½"	7' 6¾"	5' 1¾"	5 x 6"	9' 1"	3' 11¾"	9' 6"	7' 1"	2	2200	6"	10" x 3"	441
	Intermediate	US-PGSS04400I-8A	8' 2½"	4 x 8"	5' 2¼"	10' 5"	7' 1¾"	5 x 8"	11' 5¾"	5' 8"	11' 9"	8' 5½"	2	2200	8"	6" x 3"	262	
		US-PGSS04400I-10A	9' 10"	4 x 8"	6' 9¾"	10' 5"	7' 1¾"	5 x 8"	11' 5¾"	5' 8"	11' 9"	8' 5½"	2	2200	8"	6" x 3"	269	
		US-PGSS04400I-13A	12' 10¼"	6 x 8"	9' 10"	10' 5"	7' 1¾"	5 x 8"	11' 5¾"	5' 8"	11' 9"	8' 5½"	2	2200	8"	6" x 3"	284	
		US-PGSS04400I-15A	15'	8 x 8"	11' 11¾"	10' 5"	7' 1¾"	5 x 8"	11' 5¾"	5' 8"	11' 9"	8' 5½"	2	2200	8"	6" x 3"	295	
		US-PGSS04400I-18B	18' ½"	8 x 8"	15' ¼"	10' 5"	7' 1¾"	5 x 8"	11' 5¾"	5' 8"	11' 9"	8' 5½"	2	2200	8"	6" x 3"	335	
		US-PGSS04400I-27D	27' 6¾"	8 x 8"	24' 6½"	10' 3½"	7' ¾"	5 x 8"	11' 9¾"	5' 8"	12' 2¾"	8' 5½"	2	2200	8"	10" x 3"	507	
	Tall	US-PGSS04400T-8A	8' 2½"	4 x 8"	5' 2¼"	13' 4"	9' 4¾"	6 x 8"	14' 5¼"	6' 7¼"	14' 8½"	10' 9¼"	2	2200	8"	6" x 3"	289	
		US-PGSS04400T-10A	9' 10"	4 x 8"	6' 9¾"	13' 4"	9' 4¾"	6 x 8"	14' 5¼"	6' 7¼"	14' 8½"	10' 9¼"	2	2200	8"	6" x 3"	295	
		US-PGSS04400T-13A	12' 10¼"	6 x 8"	9' 10"	13' 4"	9' 4¾"	6 x 8"	14' 5¼"	6' 7¼"	14' 8½"	10' 9¼"	2	2200	8"	6" x 3"	311	
		US-PGSS04400T-15A	15'	8 x 8"	11' 11¾"	13' 4"	9' 4¾"	6 x 8"	14' 5¼"	6' 7¼"	14' 8½"	10' 9¼"	2	2200	8"	6" x 3"	322	
		US-PGSS04400T-18B	18' ½"	8 x 8"	15' ¼"	13' 4"	9' 4¾"	6 x 8"	14' 5¼"	6' 7¼"	14' 8½"	10' 9¼"	2	2200	8"	6" x 3"	362	
		US-PGSS04400T-27D	27' 6¾"	8 x 8"	24' 6½"	13' 3"	9' 3¾"	6 x 8"	14' 8 ¾"	6' 7¼"	15' 1¾"	11' 2½"	2	2200	8"	10" x 3"	534	

**Ratings using ANSI standards. Contact REID for other standards.

		Product Code	A	B	C	Dmax	Dmin	E	F	G	Hmax	Hmin	Fall Arrest Capacity** No. of Person(s)	Personnel Lifting [lb]	Castor Diameter	Beam Profile	Weight [lb]
			Beam Length	Beam Adjustment	Clear Operating Span	Max height to lifting eye	Min height to lifting eye	Height increment	Max height to top of beam	Width	Max height to top of roller	Min height to top of roller					
4400	Extra Tail	US-PGSS04400TC1-13A	12' 10¼"	6 x 8"	9' 10"	19' 1"	13' 2"	9 x 8"	20' 2"	8' 11½"	20' 5¼"	14' 6½"	2	2200	8"	6" x 3"	512
		US-PGSS04400TC1-15A	15'	8 x 8"	11' 11¾"	19' 1"	13' 2"	9 x 8"	20' 2"	8' 11½"	20' 5¼"	14' 6½"	2	2200	8"	6" x 3"	523
		US-PGSS04400TC1-18B	18' ½"	8 x 8"	15' ¼"	19' 1"	13' 2"	9 x 8"	20' 2"	8' 11½"	20' 5¼"	14' 6½"	2	2200	8"	6" x 3"	562
		US-PGSS04400TC1-27D	27' 6¾"	8 x 8"	24' 6¾"	18' 11½"	13' ½"	9 x 8"	20' 5¾"	8' 11½"	20' 10¾"	15'	2	2200	8"	10" x 3"	734
6600	Tail	US-PGSS06600T-8A	8' 2½"	4 x 8"	5' 2¼"	13' 4"	9' 4¾"	6 x 8"	14' 5¼"	6' 7¼"	14' 8½"	10' 9¼"	2	3300	8"	6" x 3"	416
		US-PGSS06600T-10A	9' 10"	4 x 8"	6' 9¾"	13' 4"	9' 4¾"	6 x 8"	14' 5¼"	6' 7¼"	14' 8½"	10' 9¼"	2	3300	8"	6" x 3"	422
		US-PGSS06600T-13B	12' 10¼"	6 x 8"	9' 10"	13' 4"	9' 4¾"	6 x 8"	14' 5¼"	6' 7¼"	14' 8½"	10' 9¼"	3	3300	8"	6" x 3"	455
		US-PGSS06600T-15B	15'	8 x 8"	11' 11¾"	13' 4"	9' 4¾"	6 x 8"	14' 5¼"	6' 7¼"	14' 8½"	10' 9¼"	3	3300	8"	6" x 3"	469
		US-PGSS06600T-18D	18' ½"	8 x 8"	15' ¼"	13' 3"	9' 3¾"	6 x 8"	14' 8¾"	6' 7¼"	15' 1½"	11' 2¼"	3	3300	8"	10" x 3"	561
		US-PGSS06600T-27D	27' 6¾"	8 x 8"	24' 6¾"	13' 3"	9' 3¾"	6 x 8"	14' 8¾"	6' 7¼"	15' 1½"	11' 2¼"	3	3300	8"	10" x 3"	660

**Ratings using ANSI standards. Contact REID for other standards.

› Quality & Safety

Regulations

This product complies with the following:

- › ANSI Z359.18-2017
- › ATEX Directive - 2014/34/EU
- › Machinery Directive 2006/42/EC
- › PPE Regulation (EU) 2016/425
- › The Provision and Use of Work Equipment Regulations 1998 (S.I. 1998 No. 2306)
- › The Lifting Operations and Lifting Equipment Regulations 1998 (S.I. 1998 No. 2307)
- › In conformity with EN795:2012, AS/NZS 5532:2013 and PD CEN/TS 16415:2013

It is essential to adhere to the safety regulations of the respective country for using manual lifting equipment.

Accreditations

Quality and safety are key themes throughout this document and the REID Lifting ethos. It is with this in mind that we have undertaken external accreditations to ensure we stay focused on what is important to our clients and users, and ahead of market trends and developments.

REID Lifting is continuously audited by Lloyds Register Quality Assurance (LRQA) for approval of its Integrated Management System combining quality systems management, environmental issues and the health and safety practices within the company.

- › ISO 9001:2015 - Specifies requirements for a quality management system for any organization that needs to demonstrate its ability to consistently provide products that meet customer and applicable regulatory requirements and aims to enhance customer satisfaction.
- › ISO 14001:2015 - Specifies the requirements for implementing environmental management systems throughout all areas of the organization.
- › ISO 45001 – Health & Safety Management System

- › LEEA Membership - REID Lifting is a full member of the Lifting Equipment Engineers Association (LEEA membership 000897). REID Lifting conforms to the main aims of the association which is to achieve the highest standards of quality and integrity in the operations of members. Entry qualifications are demanding and strictly enforced through technical audits based on the Technical Requirements for Members.
- › IRATA - REID Lifting is an associate member of the Industrial Rope Access Trade Association (IRATA International membership number 148). REID Lifting works in accordance with the IRATA Code of Practice, by doing so, contributes to promote the development of safe systems.

Conformité Européenne [CE] & UK Conformity Assessed [UKCA]

REID Lifting's products have been designed, tested and approved (as appropriate) by the Conformité Européenne and UK Conformity Assessed. This certifies that REID Lifting's products meet the demands of the European and UK Directives and Regulations regarding Health and Safety requirements. The EC type-examination for this device has been carried out by SGS United Kingdom Ltd, 202b, Worle Parkway, Westonsuper-Mare, BS22 6WA, United Kingdom (CE body no.0120) in accordance with Module B of the PPE Regulation. The EC quality assurance system for this device has been carried out by SGS Fimko Oy, Takomotie 8, FI-00380 Helsinki, Finland. (CE body no. 0598) and SGS United Kingdom Ltd, 202b, Worle Parkway, Weston-super-Mare, BS22 6WA, United Kingdom (CE body no.0120) in accordance with Module D PPE Regulation (EU) 2016/425 and as brought into UK law and amended.

Testing

Testing and technical file review are integral parts of our design and manufacturing process. External verification of products is undertaken where appropriate, using government approved Notified Bodies.

All products have been thoroughly type tested. Each system is supplied with a certificate of conformance and individual record of thorough examination or test.

Language

It is essential for the safety of the user that if this product is re-sold outside of the original country of destination, the reseller shall provide instructions for use, maintenance, inspection and repair in the language of the country where it will be used.

Product IPR

Intellectual property rights apply to all REID Lifting Ltd products. There are patents in place, or pending, for:

PORTAGANTRY™ | **PORTAGANTRY**RAPID™ | **PORTADAVIT**QUANTUM™ | **TDAVIT**™

All product names are trademarks of REID Lifting Ltd:

PORTAGANTRY™ | **PORTAGANTRY**RAPID™ | **PORTADAVIT**™ | **PORTABASE**™ | **TDAVIT**™ | **PORTAQUAD**™

> Product Labelling Key

Safety Labels



Insert and secure the bolt before loading the system.



Insert the detent pin and fully engage before loading the system.



Insert the clevis pin and secure with the clip before loading the system.



Restraint point only.



Read the operational manuals before using the system.



Ensure the pin is fully engaged.

Serial Labels



The system is not suitable for fall arrest applications.



The system is suitable for fall arrest applications. Specify number of users. Max weight of 330lb.

Product Labelling

PORTAGANTRY® 1100-6600

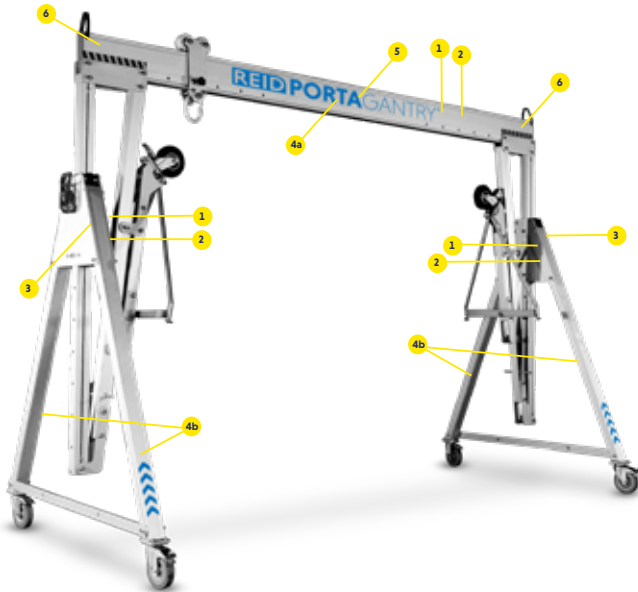

Product labelling

The following labels must be present on your system and must be legible.



➤ Product Identification & Inspection Record



Marking

The serial labels indicate:

- The product identification number
- The product's unique serial number
- The goods' capacity (WLL) of the device
- The year of manufacture
- The standards to which the device is approved
- The ATEX rating of the product (if applicable)
- CE Marking
- Minimum breaking strength (MBS) for ANSI Z359.18

Insert data from serial numbers found on product into table here:

Periodic Examination & Repair History

Date	Inspected by	Pass/Fail	Corrective Action	Comments

> Notes

Contact Us

REID Lifting Inc, USA

7900 International Drive,
Suite 300,
Bloomington,
MN 55425
USA

-  +1(888)-721-6411
-  info@reidlifting.com
-  us.reidlifting.com

All information herein is copyright protected by REID Lifting Ltd. All company and product names are Trade Mark and Trade Name protected and all REID Lifting Ltd. Product IPR is protected under Patents, Patents Pending and/or Design Rights.

 Printed using environment friendly processes and materials.