



Tuffbuilt Pro Series 1 Bracket

➤ Assembly & Operation Guide

Contents

Fitting device into Bracket	4
PORTA GANTRY <small>RAPIDE</small> 500	6
PORTA GANTRY <small>RAPIDE</small> 1000	8
PORTA GANTRY [®] Small & Medium	10
Fitting device into Bracket	12
PORTA GANTRY [®]	14
T DAVIT [®]	16
PORTA DAVIT <small>QUANTUM</small> Column	18
PORTA DAVIT <small>QUANTUM</small> Backstay	20
PORTX [®] DAVIT	22

Lightweight. Portable. **Safe.**

Please read the following instructions and guidance notes carefully. These have been designed to aid users in carrying out the correct assembly of the bracket for each of our compatible lifting systems. Systems compatible with this product are:

- **PORTA**GANTRY^[RAPIDE]
- **PORTA**GANTRY^{*}
- **T**DAVIT^{*}
- **PORTA**DAVIT^[QUANTUM]
- **PORTX**^{*} DAVIT

General Specification

- Maximum rated capacity for personnel lifting - 330lb
- Ensure the rating of the Winch is always checked before use
- For use with REID lifting products only

Standards

- Complies with the requirements of OSHA 1910 sub part I (.140) & 1926 sub part M

For further information please refer to the technical data sheet for this product.

➤ Assembly Instructions: Fitting the Device

The following instructions detail the assembly of the Tuffbuilt Pro Series 1 device into the universal bracket.

Appropriate PPE should be worn: ➤ **Gloves** ➤ **Protective Footwear**



Tuffbuilt Pro Series 1 Bracket

Assembling the **Tuffbuilt Pro Series 1 Winch** onto the bracket for trap plate attachments.

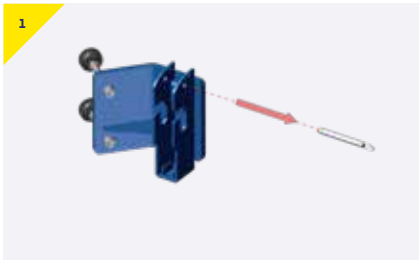

> Remove the pin from the bracket.

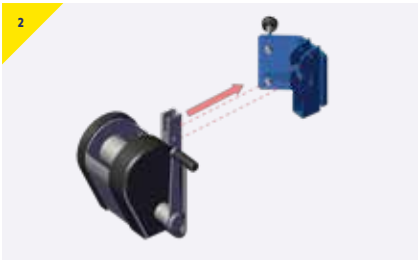

> Present the device to the bracket.

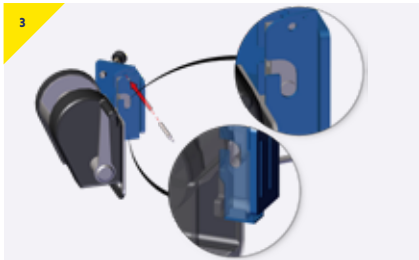

> Adjust the position, placing the device attachment arm into the bracket as shown and secure with the pin.



> The device is now ready to use.

5
Now install the product onto the trap plate.

➤ Assembly Instructions: PORTAGANTRY[®] RAPIDE[®] 500

The following instructions detail the assembly of the Tuffbuilt Pro Series 1 bracket [US-RAWB009220] for the PORTAGANTRY[®] RAPIDE[®] 500kg.

Appropriate PPE should be worn: ➤ Gloves ➤ Protective Footwear

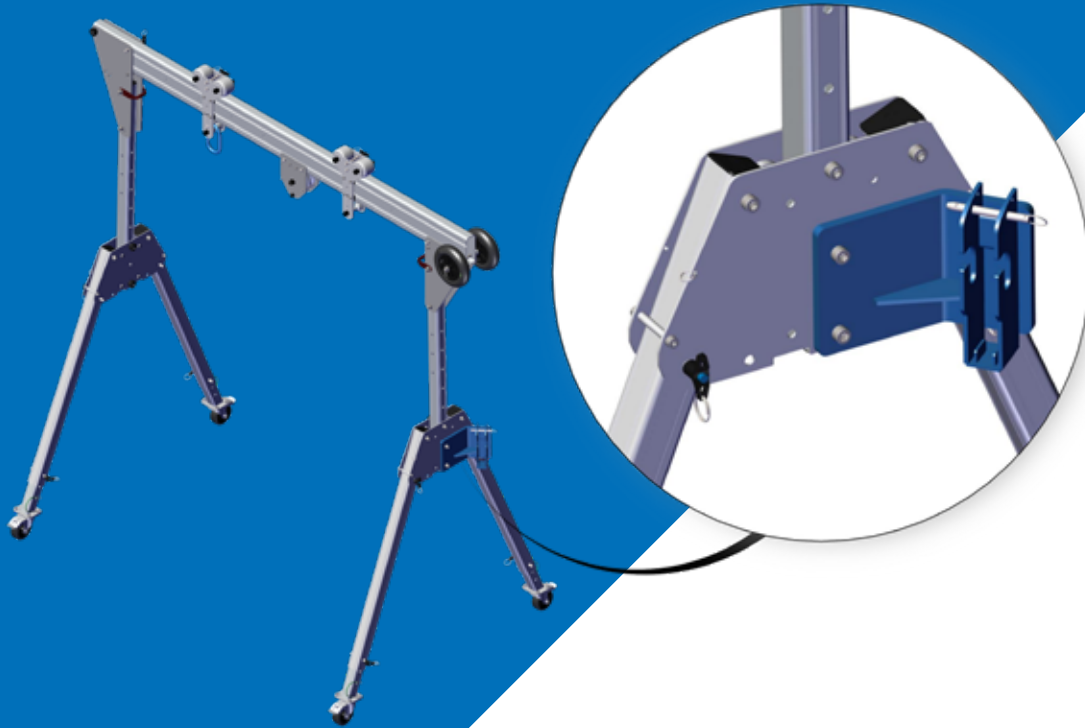

Tuffbuilt Pro Series 1 Bracket - [US-RAWB009220]

Assembling the **Tuffbuilt Pro Series 1 Bracket** on **PORTAGANTRY^{RAPIDE} 500**



- > The bracket comes with the pins and M12 bolts supplied, as shown above.

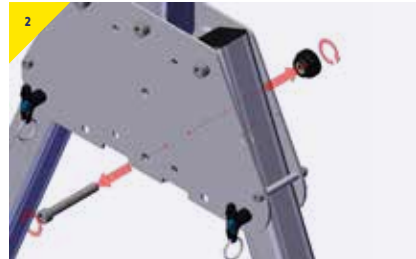

- > Remove the bottom bolt from the trap plate.

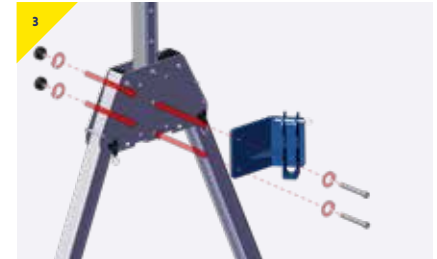

- > Present the bracket to the trap plate using the centre holes, securing with the M12 bolts.



- > The bracket is ready to receive the device.

➤ Assembly Instructions: PORTAGANTRY **RAPIDE**® 1000

The following instructions detail the assembly of the Tuffbuilt Pro Series 1 bracket [US-RAWB009220] for the **PORTAGANTRY **RAPIDE**** 1000kg.

Appropriate PPE should be worn: ➤ **Gloves** ➤ **Protective Footwear**

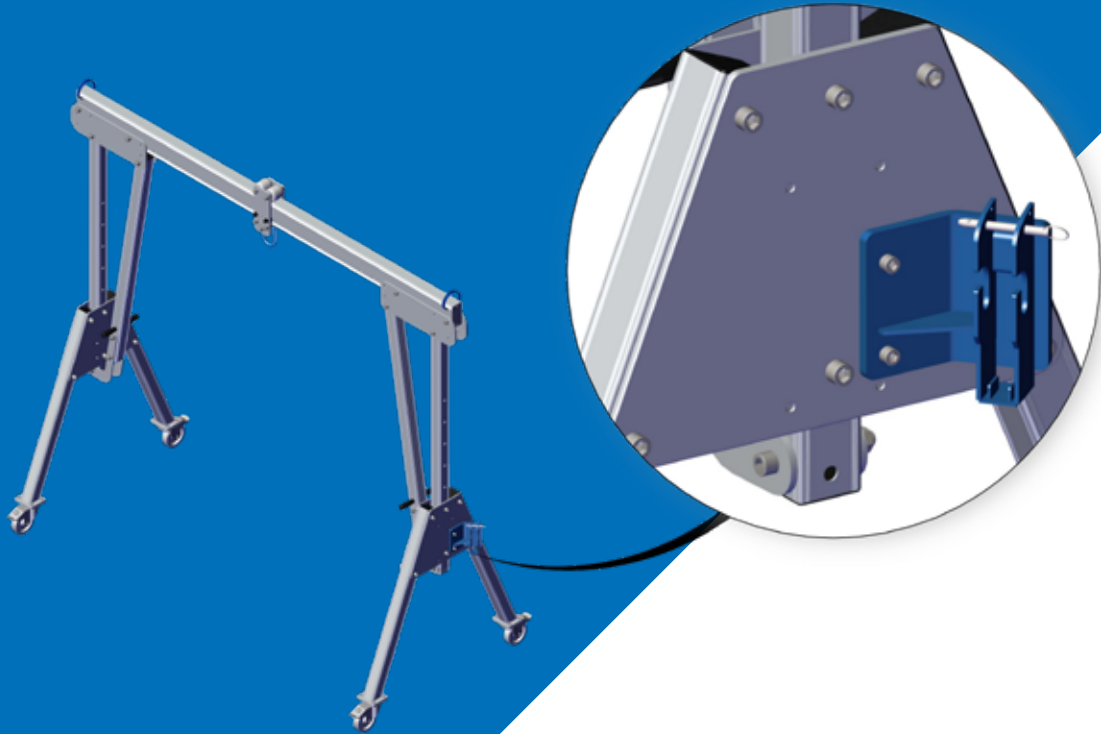

Tuffbuilt Pro Series 1 Bracket - [US-RAWB009220]

Assembling the **Tuffbuilt Pro Series 1 Bracket** on **PORTAGANTRY[®]RAPIDE[®] 1000**



- > The bracket comes with the pins and M12 bolts supplied, as shown above.

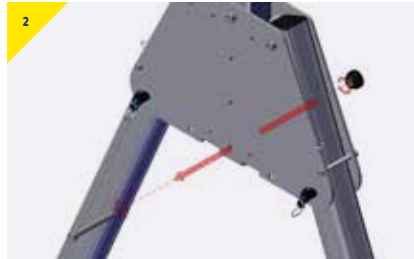

- > Remove the bottom bolt from the trap plate.

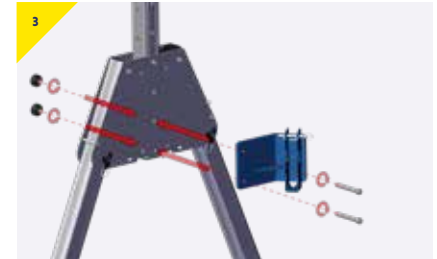

- > Present the bracket to the trap plate using the centre holes, securing with the M12 bolts.

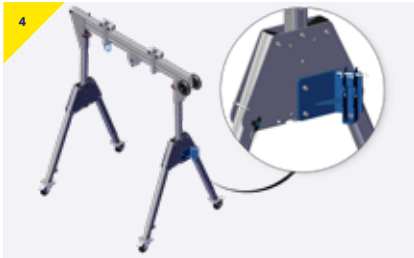

- > The bracket is ready to receive the device.

➤ Assembly Instructions: PORTAGANTRY® S & M

The following instructions detail the assembly of the Tuffbuilt Pro Series 1 bracket [US-RAWB009225] for the PORTAGANTRY® Small and Medium frame sizes.

Appropriate PPE should be worn: ➤ Gloves ➤ Protective Footwear

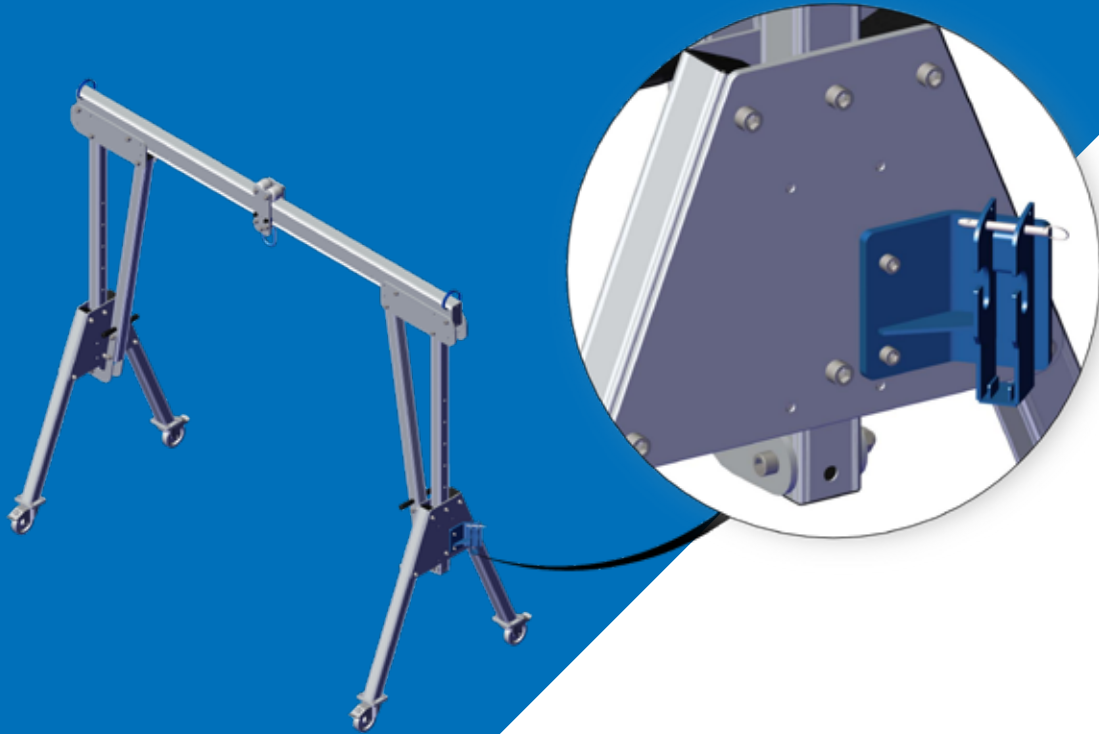

Tuffbuilt Pro Series 1 Bracket - [US-RAWB009225]

Assembling the **Tuffbuilt Pro Series 1 Bracket** onto a small or medium **PORTA**GANTRY*



- The bracket comes with the pins and M12 bolts supplied, as shown above.

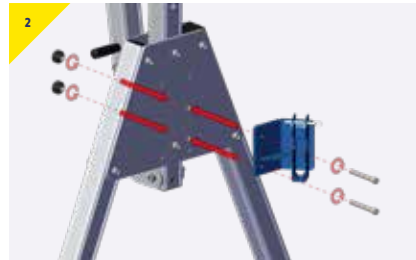

- Present the bracket to the trap plate using the centre holes, securing with the M12 bolts.

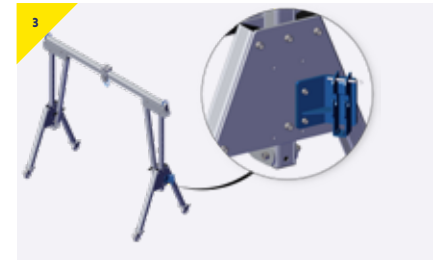

- The bracket is ready to receive the device.

➤ Assembly Instructions: Fitting the Device

The following instructions detail the assembly of the Tuffbuilt Pro Series 1 device into the universal bracket.

Appropriate PPE should be worn: ➤ **Gloves** ➤ **Protective Footwear**



Tuffbuilt Pro Series 1 Bracket

Assembling the **Tuffbuilt Pro Series 1 Winch** onto the bracket for column or backstay attachments.

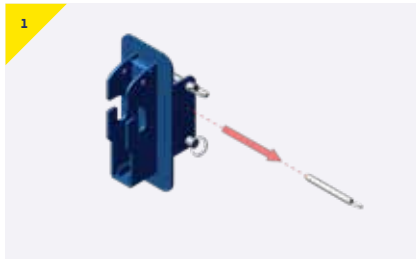

- Remove the pin from the bracket.

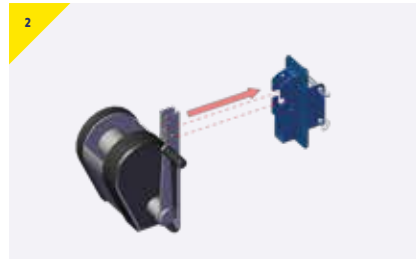

- Present the device to the bracket.

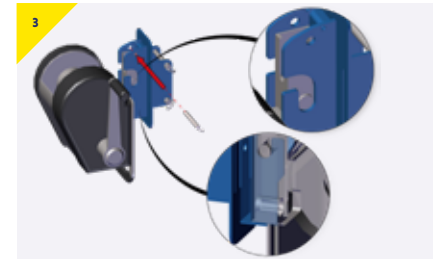

- Adjust the position, placing the device attachment arm into the bracket as shown and secure with the pin.

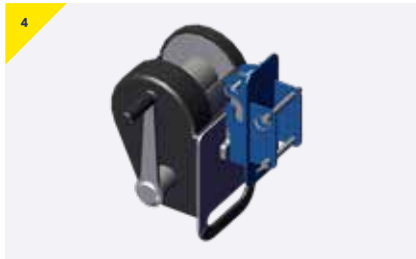

- The device is now ready to use.

**Now install the product
onto the column or backstay.**

➤ Assembly Instructions: PORTAGANTRY®

The following instructions detail the assembly of the Tuffbuilt Pro Series 1 bracket [US-RAWB009200] for the PORTAGANTRY®.

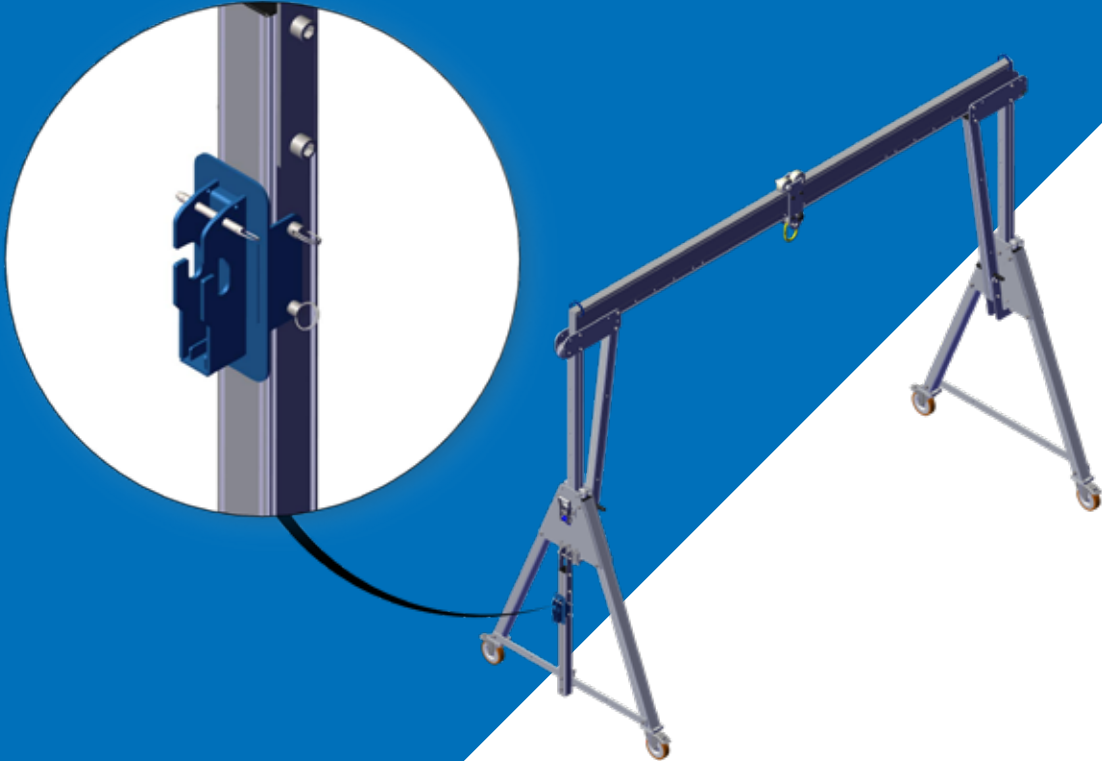

Appropriate PPE should be worn: ➤ Gloves ➤ Protective Footwear

Assembling the **Tuffbuilt Pro Series 1 Bracket** onto a **PORTAGANTRY®**



1
> The bracket comes with the pins supplied, as shown above.

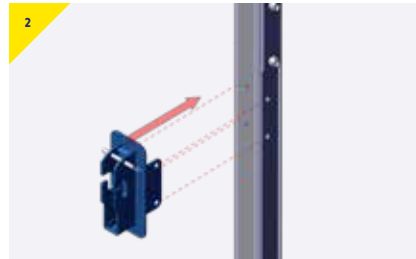

2
> Remove the pins and present the bracket to the winch column, aligned to the holes as shown.

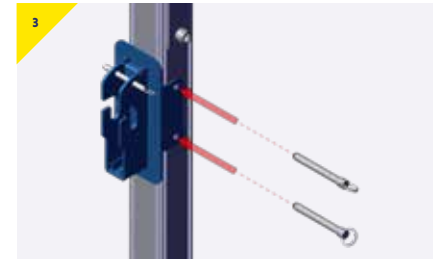

3
> Insert both pins to ensure the bracket is securely attached.



4
> The bracket is secured and ready for the device to be attached.

➤ Assembly Instructions: TDAVIT®

The following instructions detail the assembly of the Tuffbuilt Pro Series 1 bracket [US-RAWB009200] for the TDAVIT®.



Appropriate PPE should be worn: ➤ **Gloves** ➤ **Protective Footwear**

Assembling the **Tuffbuilt Pro Series 1 Bracket** onto a **TDAVIT[®]**



- The bracket comes with the pins supplied, as shown above.

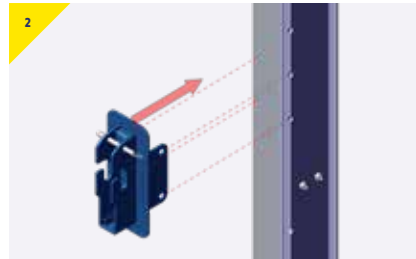

- Remove the pins and present the bracket to the column, aligned to the holes as shown.

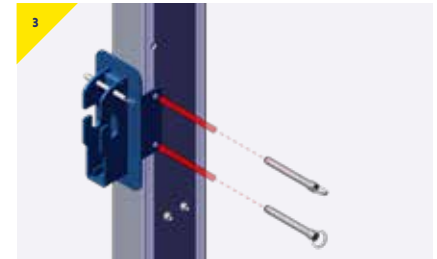

- Insert both pins to ensure the bracket is securely attached.

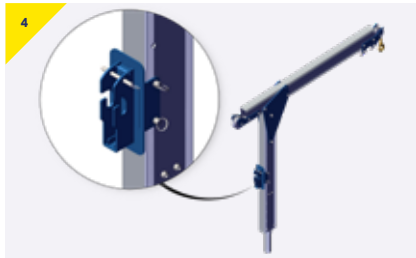

- The bracket is secured and ready for the device to be attached.

> Assembly Instructions: PORTA DAVIT QUANTUM® Column.

The following instructions detail the assembly of the Tuffbuilt Pro Series 1 bracket [US-RAWB009200] for the PORTA DAVIT QUANTUM column.

Warning: For this configuration a sheave bracket column is required.

Appropriate PPE should be worn: > Gloves > Protective Footwear



Assembling the **Tuffbuilt Pro Series 1 Bracket** onto a **PORTADAVIT^{QUANTUM}** column.



- 1 The bracket comes with the pins supplied, as shown above.

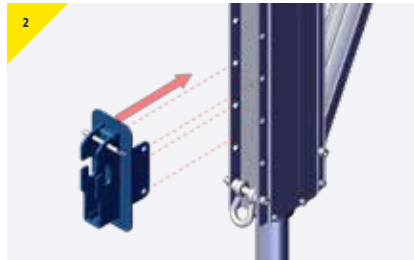

- 2 Remove the pins and present the bracket to the column, aligned to the holes as shown.

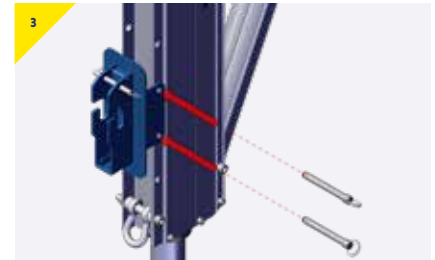

- 3 Insert both pins to ensure the bracket is securely attached.



- 4 Present the sheave bracket* to the top of the column, aligning with the top holes as shown.

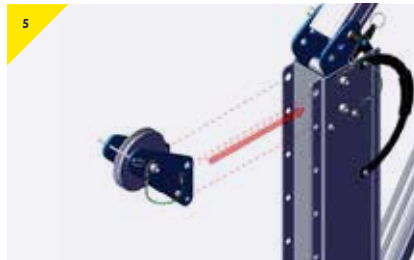

- 5 Secure using the pins provided.



- 6 The bracket is secured and ready for the device to be attached.

*US-RAW000095 - Sheave bracket PDQ Column Medium Sheave (4-7mm).

➤ Assembly Instructions: PORTADAVIT[®] QUANTUM[®] Backstay.

The following instructions detail the assembly of the Tuffbuilt Pro Series 1 bracket [US-RAWB009206] for the PORTADAVIT[®] QUANTUM[®] Backstay.

Appropriate PPE should be worn: ➤ Gloves ➤ Protective Footwear

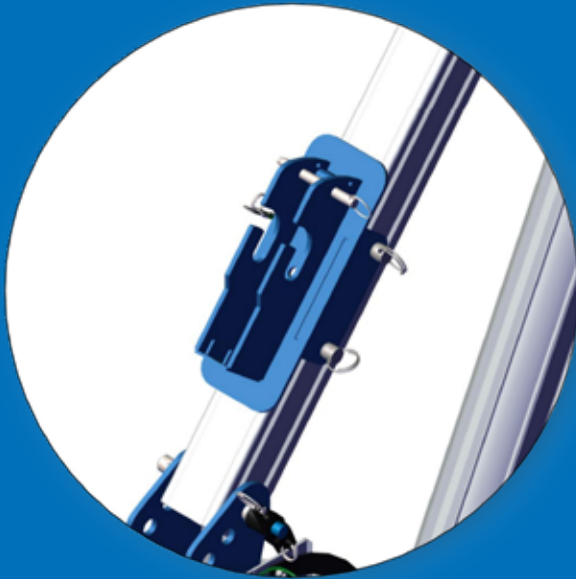

Assembling the **Tuffbuilt Pro Series 1 Bracket** onto a **PORTADAVIT^{QUANTUM}** Backstay.



- 1 The bracket comes with the pins supplied, as shown above.

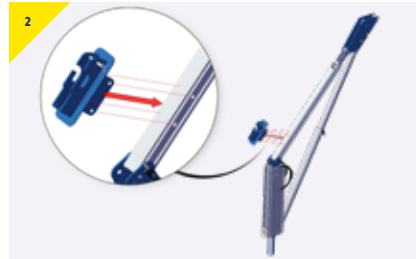

- 2 Remove the pins and present the bracket to the backstay, aligned to the holes as shown.



- 3 Insert both pins to ensure the bracket is securely attached.



- 4 The bracket is secured and ready for the device to be attached.

➤ Assembly Instructions: PORTX[®] DAVIT

The following instructions detail the assembly of the Tuffbuilt Pro Series 1 bracket [US-RAWB009200] for the PORTX[®] DAVIT.

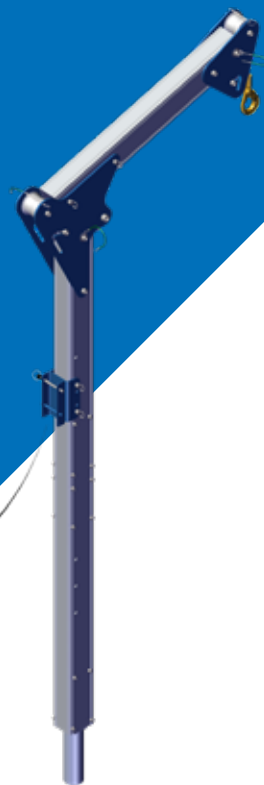
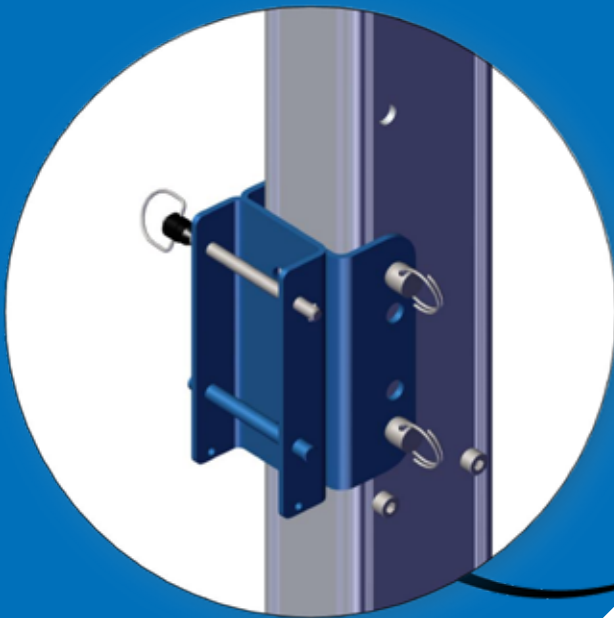

Appropriate PPE should be worn: ➤ Gloves ➤ Protective Footwear

Assembling the **Tuffbuilt Pro Series 1 Bracket** onto a **PORTX[®] DAVIT**.



1 > The bracket comes with the pins supplied, as shown above.

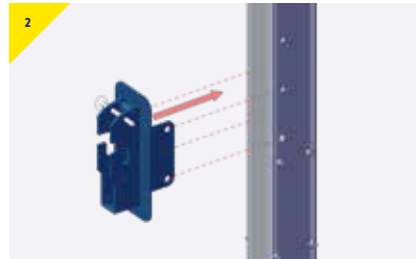

2 > Remove the pins and present the bracket to the column, aligned to the holes as shown.

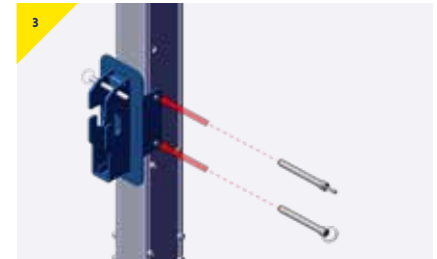

3 > Insert both pins to ensure the bracket is securely attached.

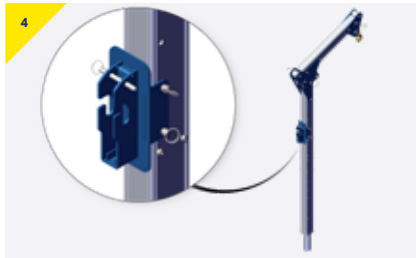

4 > The bracket is secured and ready for the device to be attached.

Contact Us

REID Lifting Inc, USA

7900 International Drive,
Suite 300,
Bloomington,
MN 55425
USA

- > +1-(888)-721-6411
- > info@reidlifting.com
- > us.reidlifting.com

All information herein is copyright protected by REID Lifting Ltd. All company and product names are Trade Mark and Trade Name protected and all REID Lifting Ltd. Product IPR is protected under Patents, Patents Pending and/or Design Rights.



Printed using environment friendly processes and materials.