

TDAVIT™

➤ Assembly & Operation Guide

> Contents

Correct Operation 4

- Intended Use
- Inspection Prior to Initial Operation
- Inspection Before Starting Work
- Maximum Capacity
- Temperature Range
- Notes for Correct Operation
- Disclaimer
- Warning
- Fall Protection
- Additional Notes for Correct Operation
- Warning

Inspection & Maintenance 8

- Regular Inspections
- Maintenance & Repair
- Storage & Transportation
- Sockets
- Socket Installation
- Minimum Mounting Requirements
- Verifying the Installation

ATEX 12

- ATEX
- Classification [Zone 2]
- Classification [Zone 1]
- Spark Formation
- Static Electricity
- Inspection, Maintenance & Repair

Assembly Instructions 14

Variants & Options 17

Dimensions 28

Quality & Safety 32

- Regulations, Standards & Directives
- Accreditations
- Conformité Européenne [CE] & UK Conformity Assessed [UKCA]
- Testing
- Language
- Product IPR

Product Labelling 34

Inspection Record 35



Lightweight. Portable. **Safe.**

Please read the following instructions and guidance notes carefully, before using or operating the system. They contain important information about how to handle and use the system in a safe and efficient way, avoiding danger, reducing repair costs and downtime, and increasing the reliability and lifespan of the system.

They apply for:

- > Operation, including preparation, troubleshooting during operation and cleaning
- > Maintenance, inspection and repair
- > Transportation

It is the responsibility of the end user to adhere to the Health & Safety and accident prevention standards and legislation valid in their respective countries and any regions in which the system is being used. A rescue plan also needs to be in place in the event of an emergency that could occur during the work. This document should form part of the overriding Risk Assessment and Method Statement required for each lift.

Intended Use

This product is intended to be used for; the lifting of goods, or the lifting of persons providing there is no risk of a fall.

This product provides a safety anchor point on the column for the prevention of falls of the person operating the davit only.

It is expected that all users of this product have the necessary medical and physical capabilities, are fully trained and competent in its safe assembly and use.

Inspection Prior to Initial Operation

Each product must be inspected prior to initial operation by a competent person to ensure that the structure is safe and that it has not been damaged by incorrect assembly, transport or storage.

Inspection Before Starting Work

Before starting work, the product assembly and all load-bearing components should be checked for visual defects as per the inspection checklist on page 8.

Maximum Capacity

Goods Lifting: This product is designed to lift and lower loads up to its rated capacity. Do not exceed the capacity indicated on the product.

Personnel Lifting: When lifting people, the overall load limit is reduced by half to provide an increased safety factor. The maximum capacity permitted by the personnel winch/accessory used in conjunction with the product also needs to be taken into account.

If this product is to be used for lifting or lowering a person where there is a risk of a fall, then a secondary line/fall arrest unit is required, connected to a separate structure which meets the requirements of OSHA 1926 Subpart M.

Only chain hoists with a capacity of up to 2200lb are suitable for this product. The structure has been designed to take into account the weight of a standard chain block but, if a device with a significant additional weight is being used, then this needs to be included within the overall capacity. Care should also be taken when using any lifting device other than a manual chain hoist in case the dynamic effects of this reduce the overall capacity of the davit. REID Lifting's representatives can provide additional advice on this if required.

Please be aware that the maximum reach is achieved when the davit is being used at approximately 75% of its maximum capacity.

Temperature Range

This product can be operated in ambient dry temperatures between -10°F to 131°F (-23° to +55°C). Consult your supplier in case of extreme working conditions. If used in sub-zero and wet conditions, fall arrest appliances characteristics may change.

Notes for Correct Operation

- We recommend the use of load-sensing or overload protection devices on all lifts
- The risk assessment and method statement must consider any factors that might apply additional loading to the system during lifting operations
- Suitable, appropriately rated winches and connection plates must be used for all applications
- Take care when transporting and storing the system to avoid damage
- Assemble only as instructed (ensure all bolts are present and fitted correctly as per instructions)
- We recommend that gloves are worn when using the equipment
- Attach the hoist to the dedicated lifting point only, making sure it is attached in a way that does not expose the user to danger by the hoist, chain or load
- Do not allow the load to swing
- Do not use the davit if the kingpin shaft is not seated correctly in the socket
- Do not use the davit if it does not rotate freely in the bearing or the bottom flange is fouled in any way, preventing free rotation of the davit

- To avoid side pull, lowering and lifting should only be carried out when the load chain forms a straight and vertical line between the load and lifting attachment point. (Refer to figure A)

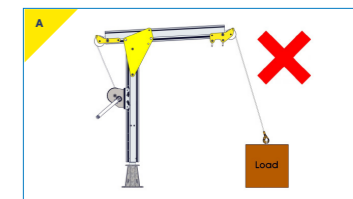

- Do not assemble davit in non-approved sockets
- Set up the product in its mounting socket ensuring that it is a safe location and there is no risk of falling into the hazard or lift area
- Attach the load only to the lifting points on the head or winch-line
- If the davit is to be used in special atmospheres contact your supplier

Disclaimer

- REID lifting sockets & extensions have been designed, developed and tested for safe use with REID equipment and form a key part of the integrity of the total system
- All sockets have a maximum moment based on the maximum reach setting of the Davit, and the socket installation and verification tests performed
- If non-standard, third-party sockets are used, REID Lifting's Declaration of Conformity & Incorporation and warranty for the products is no longer valid and the system becomes the responsibility of the client



The system is not suitable for fall arrest applications.



The system is suitable for fall arrest applications. Specify number of users. Max weight of 330lb.

Warning

- The equipment should not be used outside of its limitations, or for any purpose other than that for which it is intended
- Do not lift or transport loads while personnel are in the danger zone
- Do not allow personnel to pass under a suspended load
- Never leave a suspended load unattended
- Be aware of hazards when setting up/folding down, such as trapping fingers in rotating parts
- Be aware of any adverse weather conditions such as strong or gusty winds which could impose additional horizontal loads and affect the stability of the structure. Stop using if weather is impacting on lifting, and either disassemble the system or tie it to a rigid structure to ensure it can't overturn
- Don't allow the load to hit the system

Fall Protection

Fall arrest: This product contains a safety anchor point intended to protect the operator in the event of a fall only.

When being used for fall arrest, the operator must be equipped with a full body harness and a shock absorber that complies with the relevant national standards and regulation and that limits the Maximum Allowed Force (M.A.F.) To 8kn.

Only one person should be attached to the Davit in accordance with the notified Working Load Limit (WLL). Each lift must be properly planned, and all weights clearly known along with the WLLs and constraints of all fall arrest system components.

For custom designed davits please contact your supplier for appropriate rating and capabilities.

Additional Notes for Correct Operation

- Ensure suitable and appropriately rated winches and connection plates are used for all applications
- The fall arrest device must only be attached to the indicated lifting point on the column.
- Never walk away from the structure whilst connected to the equipment (either by winch or fall arrest block)
- When using the davit as a fall arrest anchor, ensure there is adequate fall clearance when working at height.
- Always consider the potential effects of sharp edges, chemical reagents, electrical conductivity, cutting, abrasion, climatic exposure on the fall protection lifelines, and the effect of offset forces as a result of pendulum falls
- Where regulations require, each installation must be approved by a qualified person.

Warning

- When using the Davit in conjunction with any other manufacturer's fall protection products, it is essential to read the instructions for those products to check their suitability and restrictions for use
- REID Lifting does not recommend that the davit is used for personnel and goods lifting at the same time
- It is essential for safety that the product is withdrawn from use immediately and not be used again until confirmed in writing by a competent person should,
 1. Any doubt arises about its condition for safe use or;
 2. It has been used to arrest a fall

The following information is based on REID Lifting's recommendations and does not remove the responsibility of the user to comply with the relevant regulations and standards that are valid in the respective countries and regions where the system is being used

Before each use inspect the assembly and all load-bearing components for visual defects as per the below list,

- › Ensure kingpin, beam and column are free from dents or indentations.
- › Ensure Kingpin, Beam and column are not showing any signs of deformation.
- › Ensure that there is no elongation of the beam holes and that the inserts have not become loose.
- › Ensure that the beam clevis pins are straight and free from damage.
- › Ensure that the sheaves rotate freely and that there is no visible damage
- › Ensure no bolts are loose
- › Check and brackets or attachments for signs of damage.

Test the free rotation of the kingpin and ensure that it is fully engaged in the socket. To check whether the kingpin is fully engaged, ensure that the lower bearing at the bottom of the column is flush with the top of the socket.

Regular Inspections

To ensure that the product's remains in safe working order it must be inspected regularly by a competent person. We recommend inspections every 6 months for personnel lifting and every 12 months for goods only, unless adverse working conditions or profile of use dictate shorter periods. The components of the system frame need to be checked for damage, wear, corrosion or other irregularities. It may be necessary to disassemble the system frame in order to do this. Particular attention should be paid to checking the profiles for denting, making sure there is no wear or elongation on the bolt holes and ensuring that the jib section retracts smoothly.

Any necessary repairs should only be carried out by an approved specialist workshop using original spare parts. It is recommended that once inspected or repaired, the device is marked with the date of the next inspection.

Inspections are instigated by the user. If detailed information is required on inspection and test criteria, please refer to your supplier's technical department. The equipment Inspection Record is on page 35.

If using the system in explosive atmospheres, see additional section titled ATEX.

Maintenance & Repair

In order to ensure correct operation, the conditions for inspection and maintenance must be complied with. If any defects are found, stop using the product immediately.

No alterations or additions to the equipment should be made without the written consent of the manufacturer. Any repair must be carried out in accordance with the manufacturer's procedures.

It is recommended to maintain the equipment in a clean and dry manner. Cleaning is suggested using a sponge or cloth with warm, soapy water, rinsing and allowing to dry.

This product must be assembled using metric fixings of the same type and quality as those supplied by the original manufacturer only. Failure to do so could have an impact on the structural performance and stability of the product.

Storage & Transportation

When transporting the components, take note of all the manual handling considerations.

Do not throw the product down or stack any items on top of it.

Always place carefully and security on the ground to avoid damaging the equipment.

Sockets

REID's davits need to be anchored to a suitable structural surface/foundation capable of withstanding the applicable loading. We strongly recommend that a structural engineer validates this prior to installation of the product.

This product can be supplied with one of the sockets specified below (only sockets supplied by REID Lifting are approved to be used with this product):

- › The Top Mount socket is for use on flat horizontal surfaces. It can be installed onto concrete using resin bonded anchors or into steel work using bolts.
- › The Side Mount socket can be installed using resin bonded anchors or mechanical anchors.
- › The Bridge Mount socket is for mounting into steel work and walkways.
- › The Cast & Resin Bonded sockets can be cast into new concrete or resin bonded into existing concrete.



Top Mount



Side Mount



Bridge Mount



Cast & Resin Bonded

Socket Installation

Socket installation should only be carried out by a qualified person, with the ability to specify the anchors, resin, and fasteners necessary to ensure an installation that is safe for use. If in any doubt about the calculation of loads, contact your REID Lifting representative.

Depending upon the socket type, there are a number of different installation options. If bolts are being used for this, then these should be minimum grade 8.8 BZP or if stainless, grade A4 or equivalent.

When installing the socket, it is important to ensure that the top face is as level as possible, with misalignment no more than 3 degrees from the horizontal.

Note: Site specific information regarding the installation of REID davit sockets CANNOT be detailed within this operating manual as each site/structure is different. A qualified engineer MUST design and approve each installation based on the minimum mounting requirements, site information and experience.

Minimum Mounting Requirements

The supporting structure and installed base must be capable of withstanding the following:

- › A 5000lb (22.2kN) Vertical Load 1q
- › 80000 lb-in (9kN-m) bending moment
- › 150% of the goods capacity at the device's maximum reach in all anticipated worst-case loading directions

For more detailed requirements please contact REID Lifting.

Verifying the Installation

We recommend that the socket installation is tested before initial use, particularly when using resin bonded anchors. When verifying the installation, testing should be to no more than 125% of the goods capacity at its maximum reach. All tests should be carried out in all anticipated worst-case loading directions, sustained for a duration of 3 minutes.

If the socket installation can't be tested, each anchor should be isolated and tested individually applying the applicable tension and shear loading. Please contact REID for more details.

Following initial socket installation verification tests, we recommend periodic visual examination rather than overload tests for the socket or davit. If, as a result of the visual examination, a load test is judged to be required, then we recommend a 100% load test and certainly no more than 125%.

ATEX

This product has been designed for use in explosive atmospheres in line with the following requirements and information. Any use which differs or exceeds this is considered incorrect and REID Lifting Ltd will not accept any responsibility or liability for damages resulting from false application. The risk is solely with the user. If the product has been customized in any way, then it may not comply with standards and no longer be suitable for use in explosive atmospheres. If this is the case, then the product will not have any of the markings below. If in doubt, please contact your REID representative.

Classification [Zone 2]

As standard, the product meets the requirements of Category 3 equipment for use in Zone 2 explosive atmospheres, providing a normal level of protection where mixtures of air and gases, vapours or mists or by air and dusts mixtures are unlikely to occur or, if they do occur, are likely to do so only infrequently and for a short period only.

The product will have the following identification on the serial label:

As Standard for Zone 2 Environments:

⊕ II 3 GD
 Ex h IIC T6 Gc
 Ex h IIIC T85°C Dc
 Tamb -20°C to +55°C



Classification [Zone 1]

Available as an upgrade, the product can be supplied to meet the requirements of Category 2 equipment for use in Zone 1 explosive atmospheres, providing a high level of protection where mixtures of air and gases, vapours, mists or by air and dusts mixtures are likely to occur.

The product will have the following identification on the serial label:

As an upgrade for use in Zone 1 environments:

⊕ II 2 GD
 Ex h IIC T6 Gb
 Ex h IIIC T85°C Db
 Tamb -20°C to +55°C



Spark Formation

There is an increased danger of ignition when certain material pairings clash, namely non-corrosion-resistant steel or cast iron against aluminium, magnesium or pertinent alloys. This applies especially in the case of rust or surface rust. When assembling the product and inserting fastening components, these must therefore be clear of rust and debris of any kind. As stated previously, care must be taken to ensure the product is handled in a suitable manner, never thrown down and always placed carefully onto the ground.

REID recommends the use of corrosion resistant tools when assembling this product to prevent the possibility of any sparks.

Static Electricity

For Zone 1 and 2 applications, there is a potential risk of static electricity build-up leading to an incentive spark. Although the risk of such ignition is unlikely, the system must be earthed during assembly and use. The sockets should be in direct contact with the ground and there should be no membrane separating the socket from the ground. If the route to earth for the structure cannot be guaranteed, then an earthing cable should be used.

Inspection, Maintenance & Repair

Special attention should be given to dust deposits on the structure, especially in areas where the profiles come into contact, and should be wiped clean and care taken not to apply materials that could create electrostatic charging.

Additionally, the kingpin should be checked to ensure it rotates freely and the lower bearing must be ensured to be fixed to the structure with no possibility of a build-up of debris between the contact surfaces.

The structure is predominantly constructed from aluminum which will not rust. However, there are steel components used throughout. These are the fasteners, shackles and sockets. Where there is sign of any rust deposits on the aluminium structure, it should be wiped clean as above and, where there is sign of rust on a steel component, that component should be removed from use and the structure not used until a replacement is fitted.

If using the product in explosive atmospheres, in addition to the Regular Inspection and Maintenance information above, these additional instructions should be followed:

Inspections must be instigated by the user prior to each use if used in a potentially explosive atmosphere.

Inspections and maintenance must be carried out at a safe distance away from an explosive atmosphere.

Assembly Instructions

The T DAVIT and its constituent components are described in the image below.

The use of a socket extension is optional and the socket type may vary between a Top Mount, Side Mount, Bridge Mount, Cast In or Resin Bonded, depending on application. The T DAVIT shown is a winched version but an unwinched variant is also available.

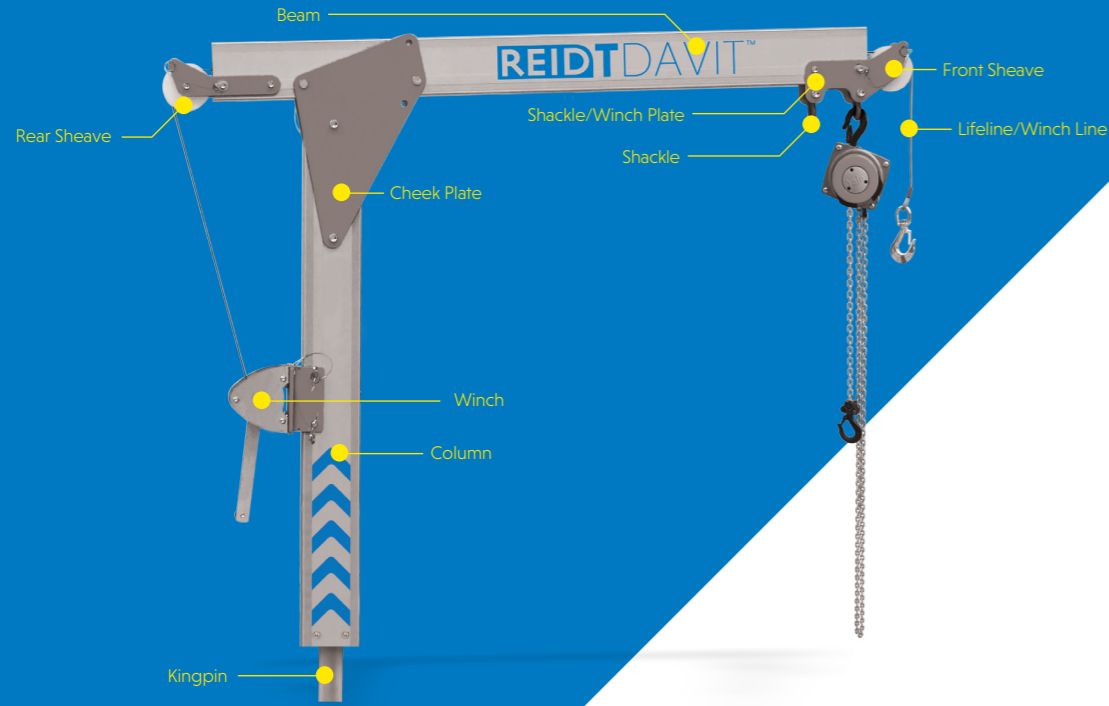

Appropriate PPE should be worn: > Hard Hat > Protective Footwear > Gloves

Assembling the T DAVIT

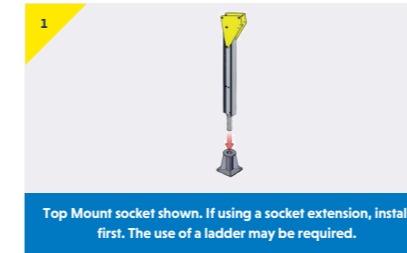

Top Mount socket shown. If using a socket extension, install first. The use of a ladder may be required.

- > Insert the T DAVIT into the socket as shown

Assembling the Winch

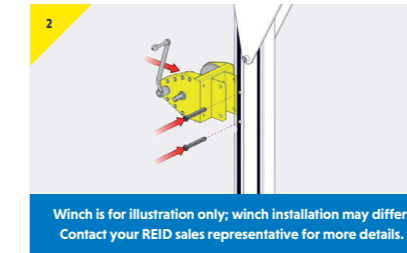

Winch is for illustration only; winch installation may differ. Contact your REID sales representative for more details.

- > Attach the winch onto the column and secure with pins.

Assembling the Beam

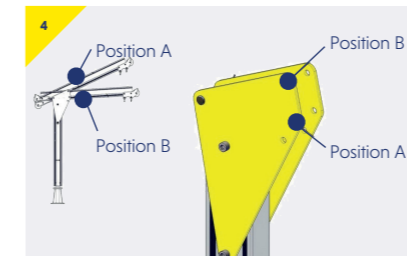

- > The T DAVIT beam can be assembled at 2 positions as shown
- > Ensure the correct set-up is chosen at this stage

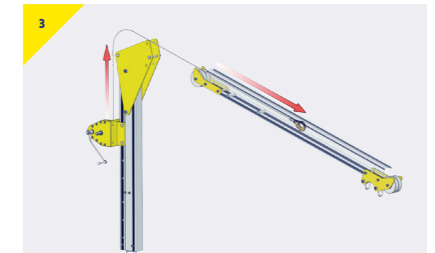

- > Play out sufficient rope to thread through the length of beam whilst at ground level
- > Thread the rope over the sheaves and through the beam as shown
- > The rope retaining pins need to be removed to fit the rope in the sheave then reinserted ensuring they are secure

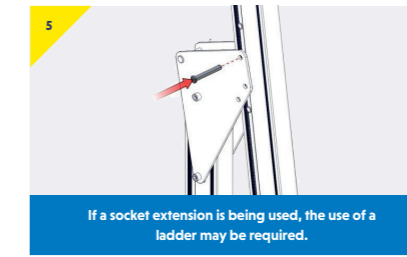

If a socket extension is being used, the use of a ladder may be required.

- > Present the beam to the chosen location and insert the clevis pin

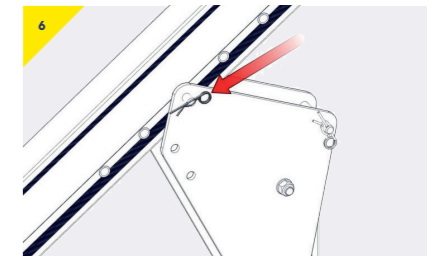

- > Secure the pin with retaining R-clip

> Assembly Instructions

TDAVIT™

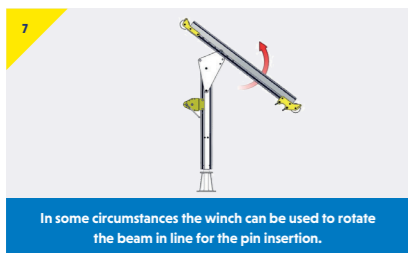

- > Rotate the beam as illustrated

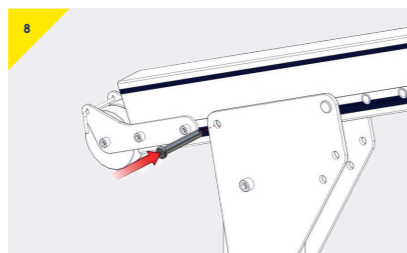

- > Insert the clevis pin to take the weight of the beam

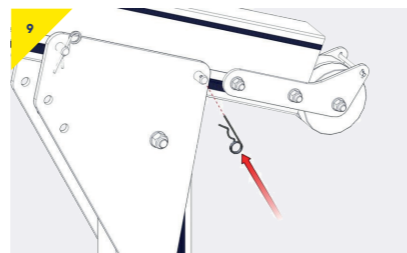

- > Secure the pin with the R-clip
- > For disassembly, reverse steps 1-9

Variants & Options.

> Type VW

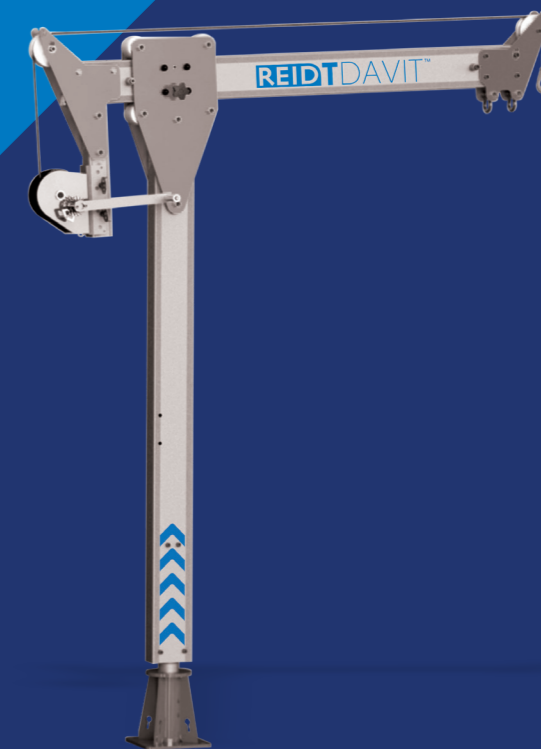

Assembly Instructions

The T DAVIT Type VW and its constituent components are described in the image below.

The use of a socket extension is optional and the socket type may vary between a Top Mount, Side Mount, Bridge Mount, Cast In or Resin Bonded, depending on application.

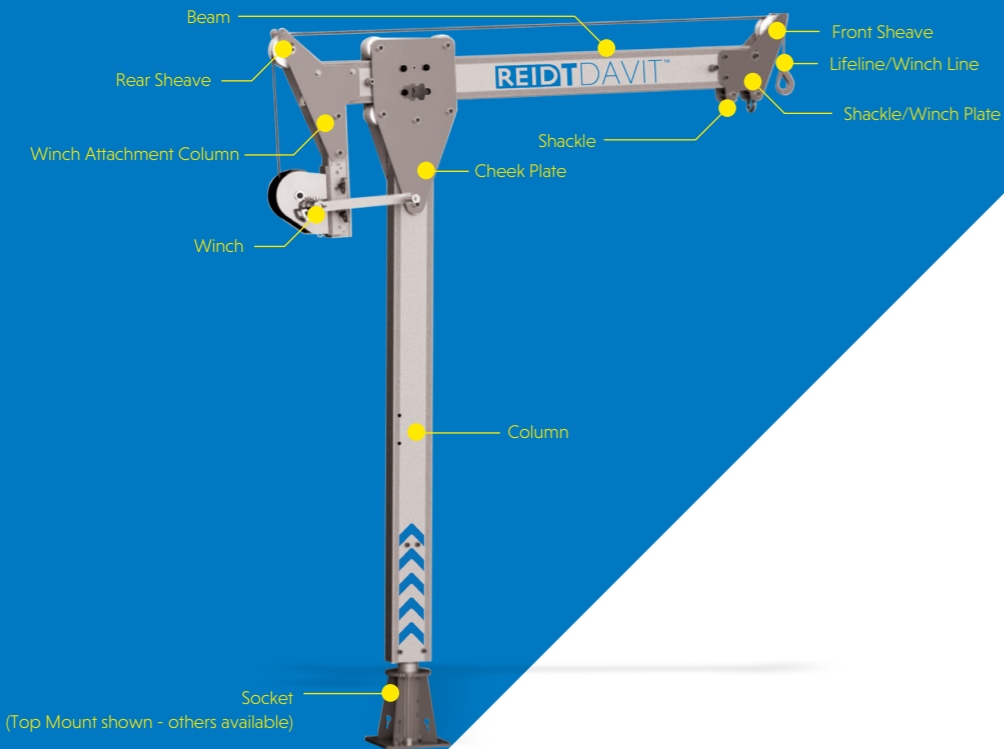

Appropriate PPE should be worn: > Gloves > Protective Footwear > Hard Hat

Assembling the T DAVIT Type VW

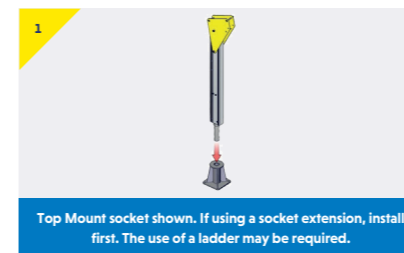

Top Mount socket shown. If using a socket extension, install first. The use of a ladder may be required.

> Insert the T DAVIT into the socket as shown

Assembling the Beam

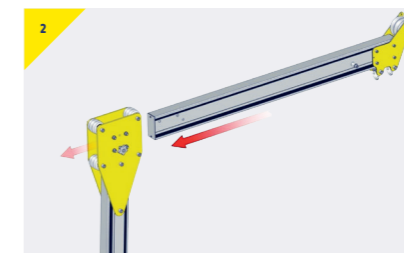

> Place the beam between rollers and slide it in

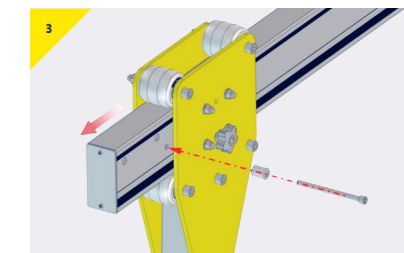

> Insert and secure bolt and spacer as shown
> This will act as a stopper to prevent the beam from disengaging

Assembling the Winch

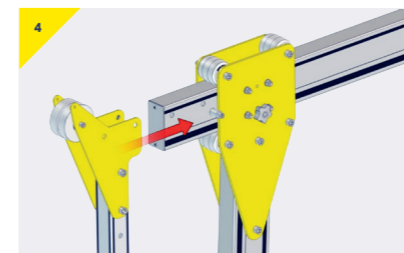

> Place winch attachment column to the beam as shown

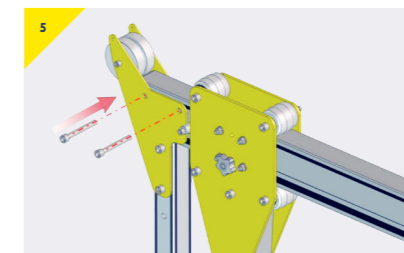

> Secure attachment with the nuts and bolts supplied

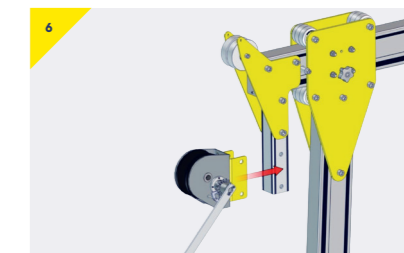

> Place the winch and bracket in position

> Assembly Instructions

TDAVIT™

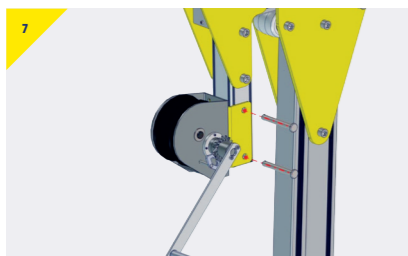

- > Secure assembly with the pins supplied

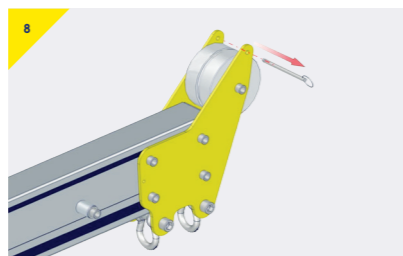

- > The rope retaining pins need to be removed before fitting the rope

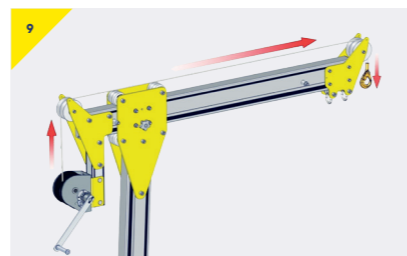

- > Thread the rope over the sheaves

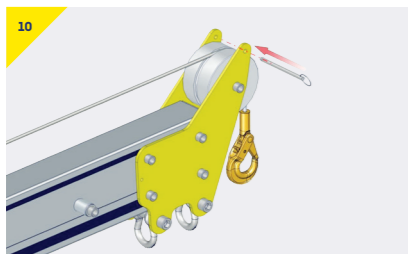

- > Reinsert pins ensuring they are secure
- > Please refer to the Operating manual of the winch before use

Variants & Options.

> Type T

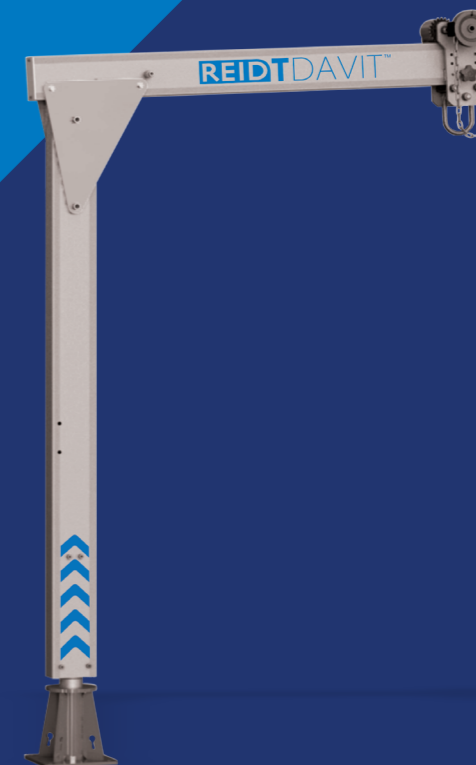

Assembly Instructions

The T DAVIT Type T and its constituent components are described in the image below.

The use of a socket extension is optional and the socket type may vary between a Top Mount, Side Mount, Bridge Mount, Cast In or Resin Bonded, depending on application.

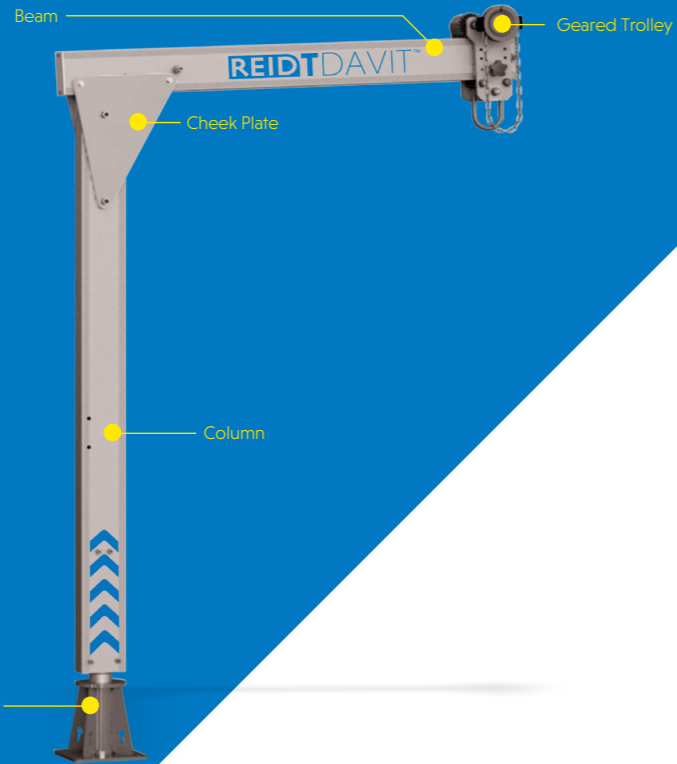

Socket
(Top Mount shown - others available)

Appropriate PPE should be worn: > Gloves > Protective Footwear > Hard Hat

Assembling the T DAVIT Type T

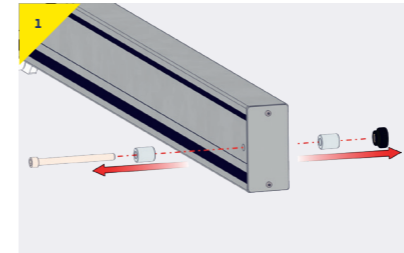

> Remove bolt and spacer at the front of the beam

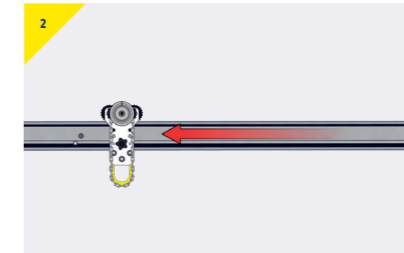

> Thread beam trolley over the end of the beam

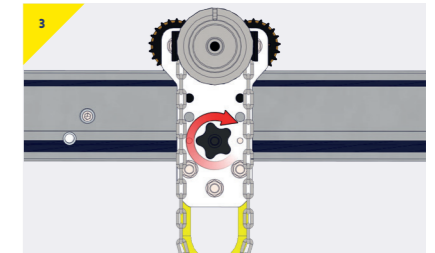

> Lock trolley with friction brake at approximately centre position

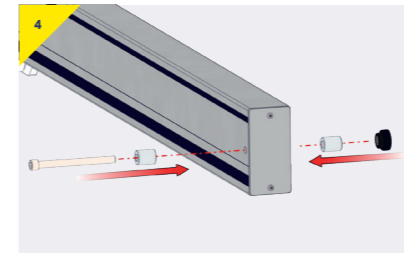

> Reinsert bolt and spacer ensuring they are secure



> Insert T Davit column into the socket

Assembling the Beam

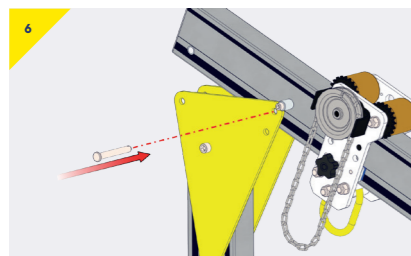

- > Present the beam to the column and insert clevis pin to take the weight of the beam

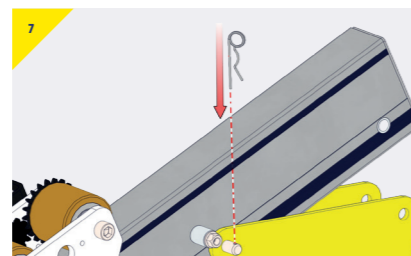

- > Secure the pin with retaining R-clip



- > Rotate the beam as illustrated

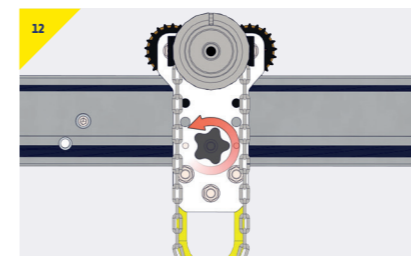

- > Release trolley brake

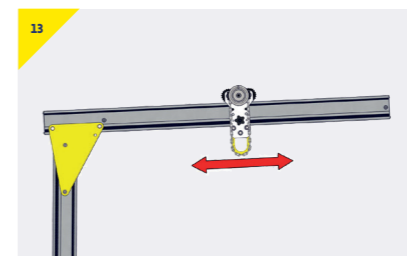

- > Use the hand chain to move the trolley along the beam

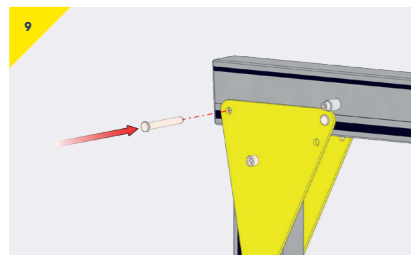

- > Insert rear clevis pin

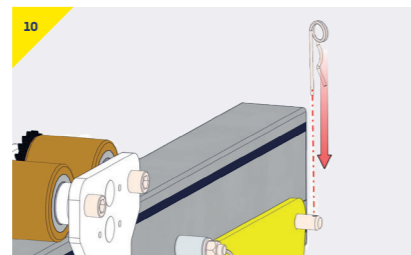

- > Secure the pin with retaining R-clip



- > The T Davit is now erect

Variants & Options.

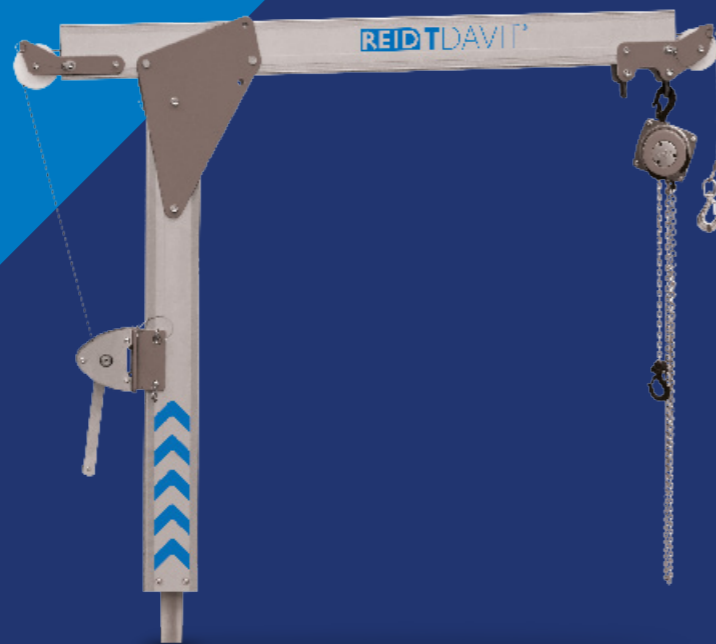

> Variants & Options

TDAVIT™

The list below outlines additional options available which can be fitted to the TDAVIT;

> Rotational Handle

Rotational Handle

A rotational handle can be fitted to the column of the davit to aid rotation underload. Dependent on the configuration users can experience a maximum effort of 78lb.

The rotation should be done in a controlled manner.

Rotation Handle Approx Effort

Davit Load [lb]	550	1100
Approximate Effort [lb]	40	78

When the rotational handle is attached to the Davit the following points must be observed:

- > Attach the rotational handle to the column of the Davit at a suitable height [Ideal position should be around hip height]. Secure in place with the pins provided. [See Figure 1]
- > Rotate the handle upwards 90° to be perpendicular to the Davit column. [See Figure 2].
- > Push and pull the handle to rotate the Davit. [See Figure 3].

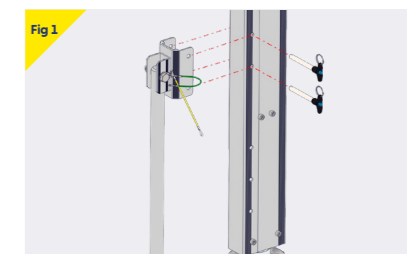

TDAVIT™

Type W

- A Reach | Position A
- B Reach | Position B
- C Height of Lift | Position A
- D Height of Lift | Position B
- W1 Winch Position 1
- W2 Winch Position 2
- W3 Winch Position 3
- W4 Winch Position 4
- W5 Winch Position 5
- P1 Height of Pin Position 1
- P2 Height of Pin Position 2

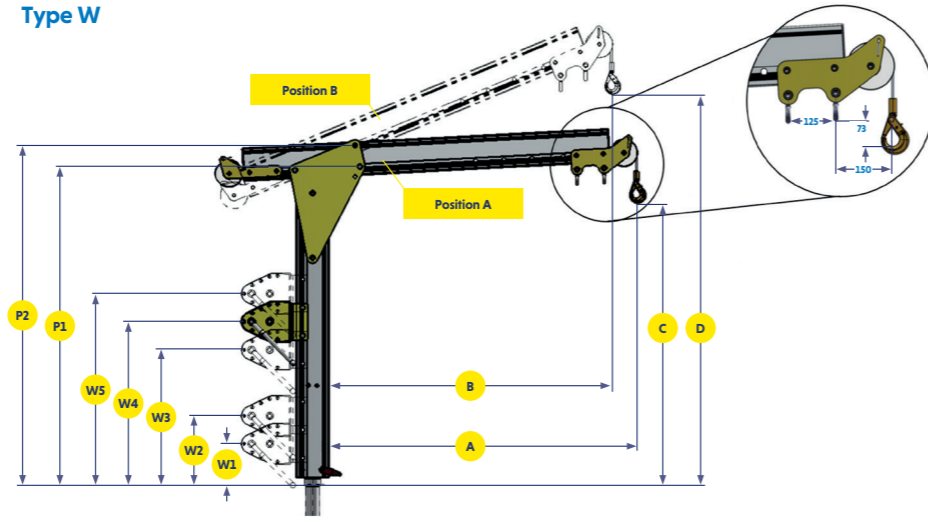

Beam Option	0		1		2		3							
Beam Length	46¾"		57"		65"		80¾"							
DIMENSION	A	B	A	B	A	B	A	B						
Reach	31½"	29¼"	39¼"	36½"	47¼"	43¾"	63"	58½"						
Capacity [LB]	1320		1100		1100		820							
Beam Weight [LB]	25		26		29		35							
DIMENSION	C	D	C	D	C	D	C	D	Weight	Winch Position	P1	P2		
Column Option	3	50¾"	60¾"	51¼"	63½"	51½"	66½"	52¼"	72¼"	51	W1	8¾"	58"	62"
											W2	12½"		
											W3	26½"		
											W4	30½"		
											W5	34½"		
4	63¾"	73"	63½"	76"	64"	79"	64¾"	84¾"	55	W3	26½"	70½"	74½"	
										W4	30½"			
										W5	34½"			
5	75½"	85¼"	75¾"	88¼"	76¼"	91¼"	77"	96¾"	62	W5	34½"	82¾"	86½"	

Dimensions are to hook on Winched type.

*Radii achieved at 75% Capacity

TDAVIT™

Type S

- A Radius | Position A
- B Radius | Position B
- C Height of Lift | Position A
- D Height of Lift | Position B
- P1 Height of Pin Position 1
- P2 Height of Pin Position 2

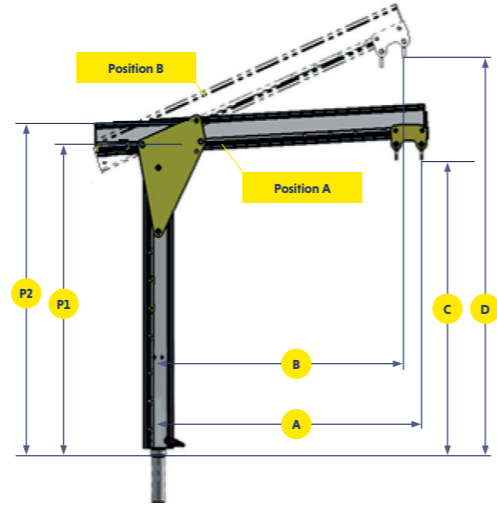

Beam Option	1		2		3	
BEAM LENGTH	57"		65"		80 3/4"	
DIMENSION	A	B	A	B	A	B
REACH	33 1/4"	30 1/2"	41 1/4"	37 3/4"	57"	52 1/4"
LOAD RATING (lbs)	1100		1100		820	
WEIGHT (lbs)	22		24		30	

Column Option	3		4		Weight (lbs)	Winch Position	P1	P2			
	C	D	C	D							
3	52"	64 1/2"	52"	67 1/2"	N/A	N/A	51	W1	7 1/2"	58"	61 3/4"
								W2	12 1/2"		
								W3	24 1/2"		
								W4	29 3/4"		
								W5	34 3/4"		
4	N/A	N/A	64 3/4"	80"	64 3/4"	86"	55	W3	24 1/2"	70 3/4"	74 3/4"
								W4	29 3/4"		
								W5	34 3/4"		

*Radii achieved at 75% Capacity

Regulations, Standards & Directives

This product complies with the following:

- › ATEX Directive - 2014/34/EU
- › Machinery Directive 2006/42/EC
- › PPE Regulation (EU) 2016/425
- › The Provision and Use of Work Equipment Regulations 1998 (S.I. 1998 No. 2306)
- › The Lifting Operations and Lifting Equipment Regulations 1998 (S.I. 1998 No. 2307)
- › In conformity with EN795:2012, AS/NZS 5532:2013 and PD CEN/TS 16415:2013

It is essential to adhere to the safety regulations of the respective country for using manual lifting equipment.

Accreditations

Quality and Safety are at the heart of the REID Lifting ethos and we are committed to maintaining the very highest standards. With this in mind, we have undertaken external accreditations to ensure we stay focused on what is important to our clients and users, and ahead of market trends and developments.

REID Lifting is continuously audited by Lloyds Register Quality Assurance (LRQA) for approval of its Integrated Management System combining quality systems management, environmental issues and the health and safety practices within the company.

- › ISO 9001:2015 - Quality management system which assesses an organization's ability to consistently provide products that meet customer and applicable regulatory requirements and aims to enhance customer satisfaction.
- › ISO 14001:2015 - Specifies the requirements for implementing environmental management systems throughout all areas of the organization.
- › ISO 45001 – Health & Safety Management System

- › LEEA Membership - REID Lifting is a full member of the Lifting Equipment Engineers Association (LEEA membership 000897). REID Lifting conforms to the main aims of the association which is to achieve the highest standards of quality and integrity in the operations of members. Entry qualifications are demanding and strictly enforced through technical audits based on the Technical Requirements for Members.

- › IRATA - REID Lifting is an associate member of the Industrial Rope Access Trade Association (IRATA International membership number 148). REID Lifting works in accordance with the IRATA Code of Practice and, in doing so, contributes to promote the development of safe systems.

Conformité Européenne [CE] & UK Conformity Assessed [UKCA]

REID Lifting's products have been designed, tested and approved (as appropriate) by the Conformité Européenne and UK Conformity Assessed. This certifies that REID Lifting's products meet the demands of the European and UK Directives and Regulations regarding Health and Safety requirements. The EC type-examination for this device has been carried out by SGS United Kingdom Ltd, 202b, Worle Parkway, Westonsuper-Mare, BS22 6WA, United Kingdom (CE body no.0120) in accordance with Module B of the PPE Regulation. The EC quality assurance system for this device has been carried out by SGS Fimko Oy, Takomotie 8, FI-00380 Helsinki, Finland. (CE body no. 0598) and SGS United Kingdom Ltd, 202b, Worle Parkway, Weston-super-Mare, BS22 6WA, United Kingdom (CE body no.0120) in accordance with Module D PPE Regulation (EU) 2016/425 and as brought into UK law and amended.

Testing

Testing and technical file review are integral parts of our design and manufacturing process. External verification of products is undertaken where appropriate, using government approved Notified Bodies.

All products have been thoroughly type tested. Each product is supplied with a certificate of conformance and individual record of thorough examination or test.

Language

It is essential for the safety of the user that if this product is re-sold outside of the original country of destination, the reseller shall provide instructions for use, maintenance, inspection and repair in the language of the country where it will be used.

Product IPR

Intellectual property rights apply to all REID Lifting Ltd products. There are patents in place, or pending, for:

PORTAGANTRY™ | PORTAGANTRY^{RAPIDE}™ | PORTADAVIT^{QUANTUM}™ | TDAVIT™

All product names are trademarks of REID Lifting Ltd.

PORTAGANTRY™ | PORTAGANTRY^{RAPIDE}™ | PORTADAVIT™ | PORTABASE™ | TDAVIT™ | PORTAQUAD™

Product Labelling Key

Safety Labels



Insert and secure the bolt before loading the system.



Insert the detent pin and fully engage before loading the system.



Insert the clevis pin and secure with the clip before loading the system.



Restraint point only.



Read the operational manuals before using the system.



Ensure the pin is fully engaged.

Serial Labels



The system is not suitable for fall arrest applications.



The system is suitable for fall arrest applications. Specify number of users. Max weight of 330lb.

Product Labelling

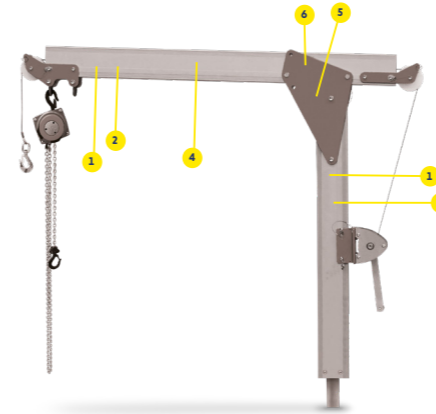
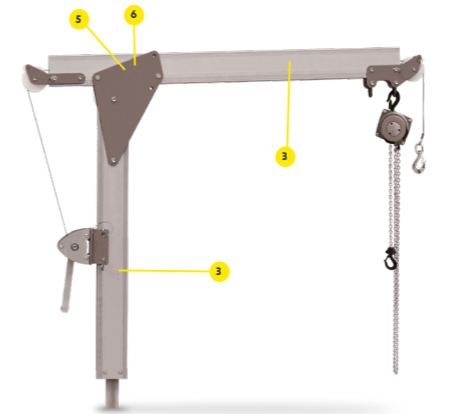

Product labelling

The following labels must be present on your system and must be legible.

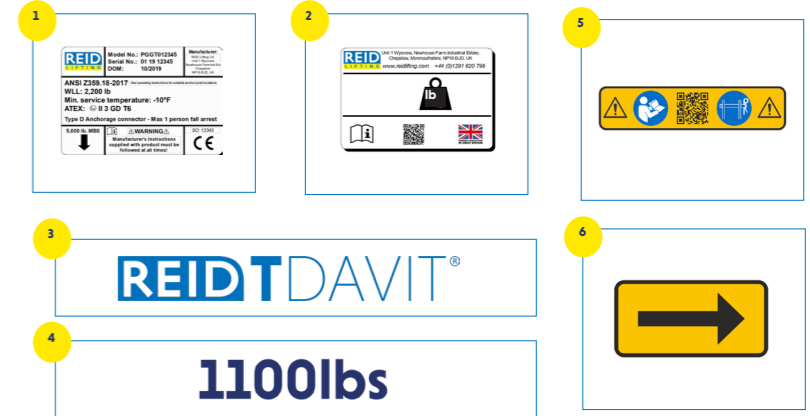

Contact Us

REID Lifting Inc, USA

7900 International Drive,
Suite 300,
Bloomington,
MN 55425
USA

-  +1-(888)-721-6411
-  info@reidlifting.com
-  us.reidlifting.com

All information herein is copyright protected by REID Lifting Ltd. All company and product names are Trade Mark and Trade Name protected and all REID Lifting Ltd. Product IPR is protected under Patents, Patents Pending and/or Design Rights.

 Printed using environment friendly processes and materials.