



 TDAVIT<sup>®</sup> TDT

**Integrated Geared Trolley Variant**

US [REIDLIFTING.COM](http://REIDLIFTING.COM)

# ➤ Product Overview

Our TDAVIT®- TDT is lightweight, portable and has been designed to meet customer needs where the lifting and moving of equipment in tight spaces is a challenge.

A truly unique product, it offers a lifting capacity of up to 880lb in combination with a geared trolley which is able to traverse the beam, in addition to 360 degree rotation under load.

It is very well suited to plant rooms, engine rooms and kiosks or any area where space is a premium and flexibility in lifting, traversing and moving loads is needed.

## Configurations

The TDT is available in several standard configurations to meet with customers most common requirements. Custom solutions can be offered by request, subject to the working load limit requirements.

## Key features

- A range of 3 column and 4 beam sizes to suit customer specific needs
- Variable beam traversing via integrated geared trolley and customers choice of hoist
- Trolley can be secured during lift
- Trolley can be traversed whilst under load (34¼" to 45¾" of movement)
- Rotation under load due to patented integral bearing system
- Universal kingpin fits all REID sockets
- Manufactured from marine grade alloy and anodized/powder coated for increased corrosion resistance
- Quality engineering and production parts reduce weight and provide high strength to weight ratios
- Two piece design to reduce manual handling concerns during transportation and assembly
- ATEX Zone 2 (explosive atmospheres) certification as standard
- ATEX Zone 1 (explosive atmospheres) as optional upgrade
- Can be assembled and operated by one person. No tools required



The **TDT** can be combined with many proprietary manual hand chain hoists. Suitable hoists are available from REID Lifting and can be combined with the product to provide a holistic lifting solution or can be purchased via our network of resellers operating in your area.

## Features & Performance

	1200	1500	1700	2000
<b>Accreditations, Certifications &amp; Standards</b>				
Directive 2006/42/EC	✓	✓	✓	✓
ATEX Certified [Zone 1]	Optional	Optional	Optional	Optional
<b>Capacity</b>				
Max Goods Lifting (lb)	880	880	440	440
<b>Dimensions</b>				
Maximum Reach (inches)	47¾	59¾	67	78¾
Maximum Height of Lift (inches)	76½	77¾	77¾	78¾
<b>Socket Diameter</b>				
2"Ø	✓	✓	✓	✓
<b>Socket Options</b>				
Top Mount	✓	✓	✓	✓
Flush Mount	✓	✓	✓	✓
Side Mount	✓	✓	✓	✓
Bridge Mount	✓	✓	✓	✓
Pedestal	✓	✓	✓	✓
<b>Standard Features</b>				
Component Weight < 55lb	✓	✓	✓	✓
Geared Trolley	✓	✓	✓	✓
<b>Finishes</b>				
Anodised	✓	✓	✓	✓
316SS Fixings	Optional	Optional	Optional	Optional
Marine Spec	Optional	Optional	Optional	Optional



# ► Technical Information

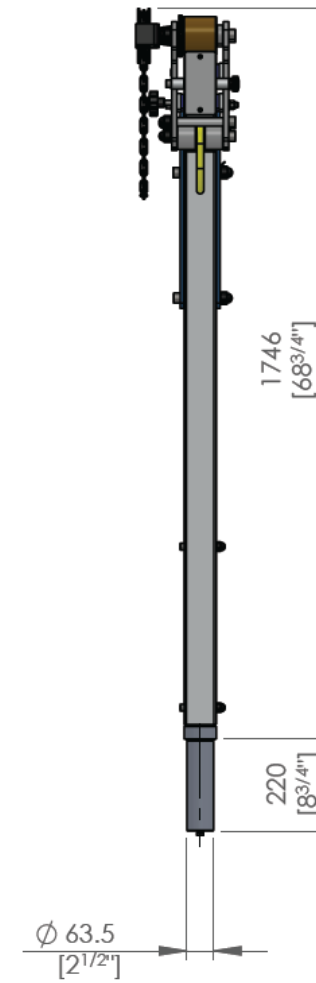
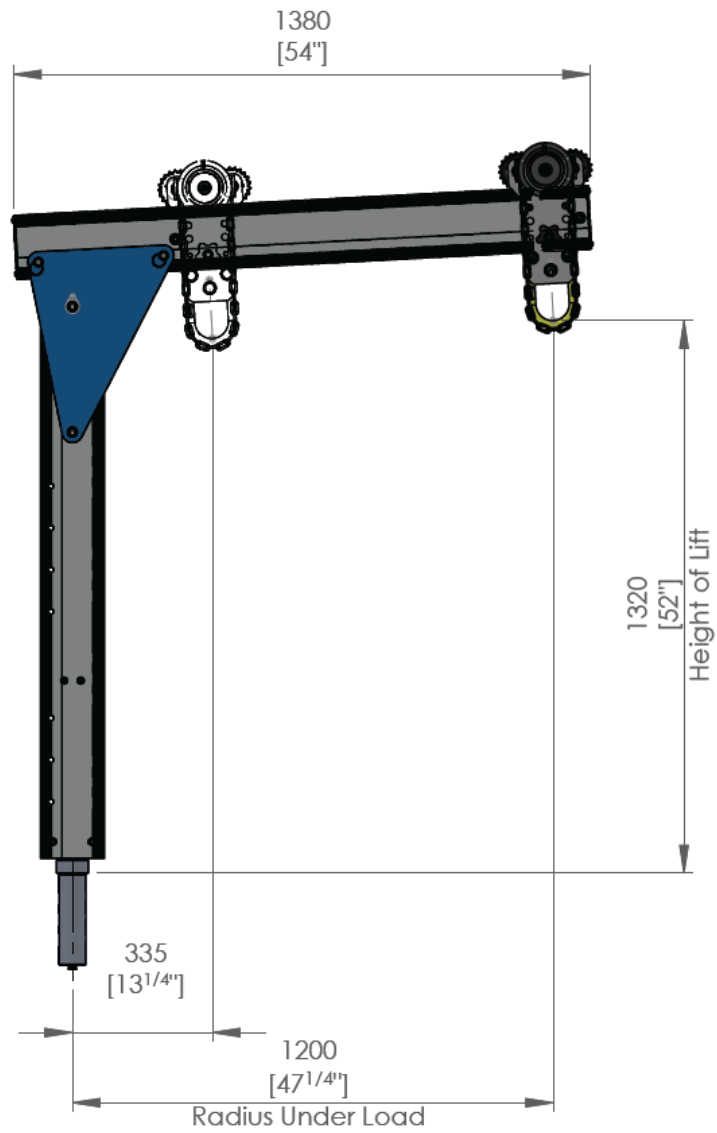

Dimensions shown reflect a single variant, not entire range.

Below is a list of standard **TDT** variants, available from stock.

Custom sizes are available if required, subject to limitations.

For more information, please email our team at: [enquiries@reidlifting.com](mailto:enquiries@reidlifting.com)

## Part Numbers and Key Metrics

Part Number	Description	≈ effort on handchain to move trolley under load	Max WLL (Capacity) lb	Overall Davit Height (from Top of Socket) inches	"Max Height of Lift inches"	"Overall Beam Length inches"	"Max Radius inches"	"Min Radius inches"	"Range of Trolley Travel inches"
US-TDTA5047	T-Davit Type T Column 5 Radius 47" WLL880lb	22-33 lb	880lb	93¼"	76½"	54¼"	47¼"	13¼"	34¼"
US-TDTA5059	T-Davit Type T Column 5 Radius 59" WLL880lb	22-33 lb	880lb	94"	77¼"	65¼"	59¼"	13¼"	45¼"
US-TDTA5067	T-Davit Type T Column 5 Radius 67" WLL440lb	11-22 lb	440lb	94½"	77¼"	73¼"	67"	13¼"	53¼"
US-TDTA5078	T-Davit Type T Column 5 Radius 78" WLL440lb	11-22 lb	440lb	95"	78¼"	85"	78¼"	13¼"	65½"

US-TDTA4047	T-Davit Type T Column 4 Radius 47" WLL880lb	22-33 lb	880lb	81¼"	64½"	54¼"	47¼"	13¼"	34¼"
US-TDTA4059	T-Davit Type T Column 4 Radius 59" WLL880lb	22-33 lb	880lb	81¾"	65"	65¼"	59¼"	13¼"	45¼"
US-TDTA4067	T-Davit Type T Column 4 Radius 67" WLL440lb	11-22 lb	440lb	82¼"	65½"	73¼"	67"	13¼"	53¼"
US-TDTA4078	T-Davit Type T Column 4 Radius 78" WLL440lb	11-22 lb	440lb	82¾"	66"	85"	78¼"	13¼"	65½"

US-TDTA3047	T-Davit Type T Column 3 Radius 47" WLL880lb	22-33 lb	880lb	64¾"	52"	54¼"	47¼"	13¼"	34¼"
TDTA31500	T-Davit Type T Column 3 Radius 59" WLL880lb	22-33 lb	880lb	69¼"	52½"	65¼"	59¼"	13¼"	45¼"
US-TDTA3067	T-Davit Type T Column 3 Radius 67" WLL440lb	11-22 lb	440lb	69 ¾"	53"	73¼"	67"	13¼"	53¼"
US-TDTA3078	T-Davit Type T Column 3 Radius 78" WLL440lb	11-22 lb	440lb	70¼"	53½"	85"	78¼"	13¼"	65½"

Please note, that the TDT comes with a 1" hand chain as standard. Should you require additional chain length, this will need to be quoted for separately using the part code: RACB000001Y

# > Sockets

## > Top Mount Socket



Product Code	Description	Material	Weight [lb]
STMG0500V2	Socket Top Mount 65 GMS	Galvanized Steel	29
STMS0500V2	Socket Top Mount 65 316SS	Stainless Steel	37
STMA0500	Socket Top Mount 65 Aluminum Natural Anodised	Aluminum	20

- > **Key features**
  - > Secured using 4nr. M16 anchors [not supplied]
  - > Suitable for resin fixing in concrete or through fixing in other substrates

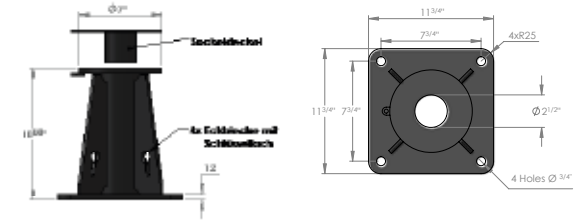

## > Side Mount Socket



Product Code	Description	Material	Weight [lb]
SSMG0500V2	Socket Side Mount 65 GMS	Galvanized Steel	29
SSMS0500V2	Socket Side Mount 65 316SS	Stainless Steel	37
SSMA0500	Socket Side Mount 65 Aluminum Natural Anodised	Aluminium	13

- > **Key features**
  - > Secured using 4nr. M16 anchors [not supplied]
  - > Suitable for mounting on the side of concrete or steel structures
  - > A brace plate can be supplied for thin-walled concrete

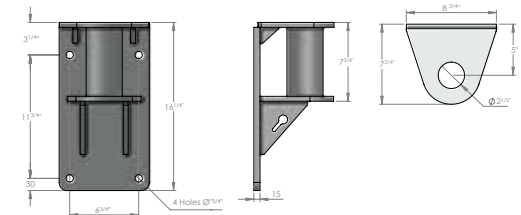

## > Bridge Mount Socket

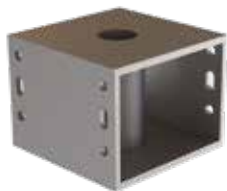

Product Code	Description	Material	Weight [lb]
SBMG0500	Socket Bridge Mount 65 GMS	Galvanized Steel	42
SBMS0500	Socket Bridge Mount 65 316SS	Stainless Steel	42
SBMA0500	Socket Bridge Mount 65 Aluminum Natural Anodised	Aluminium	42

- > **Key features**
  - > Secured using 4nr. M16 anchors (not supplied)
  - > Suitable for bolting into steel structures
  - > Designed to fit open mesh grating or flush with structural steel work

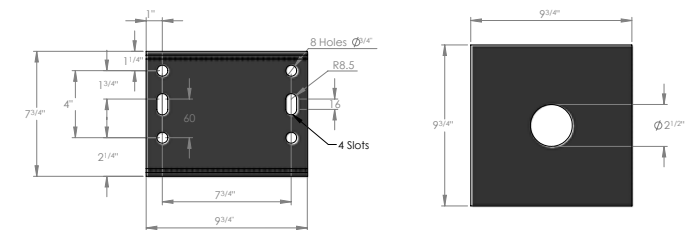

## > Flush Mount Socket



Product Code	Description	Material	Weight [klb]
SFMG0500	Socket Flush Mount 65 GMS	Galvanized Steel	11
SFMS0500	Socket Flush Mount 65 316SS	Stainless Steel	9
SFRG0500	Socket Flush Mount Resin Bond 65 GMS	Galvanized Steel	11
SFRS0500	Socket Flush Mount Resin Bond 65 316SS	Stainless Steel	9

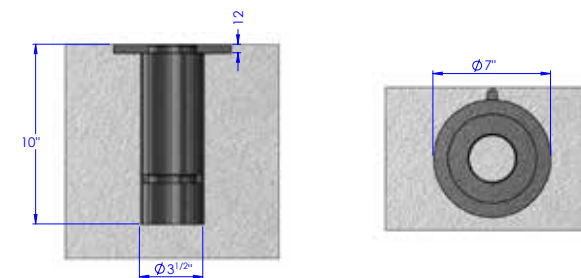

- > **Key features**
  - > Suitable for resin fixing in concrete
  - > Complete with cover and re-bars, for casting into concrete

## > Flush Pedestals



Product Code	Description	Material	Weight [lb]
SP0500-0500	Socket Pedestal 65 500mm	Aluminum	17
SP0500-0800	Socket Pedestal 65 800mm	Aluminum	19
SP0500-1100	Socket Pedestal 65 1100mm	Aluminum	19

- > **Key features**
  - > Suitable for use with 65mm kingpin
  - > Secured using 4nr. M16 or M20 anchors [not supplied]

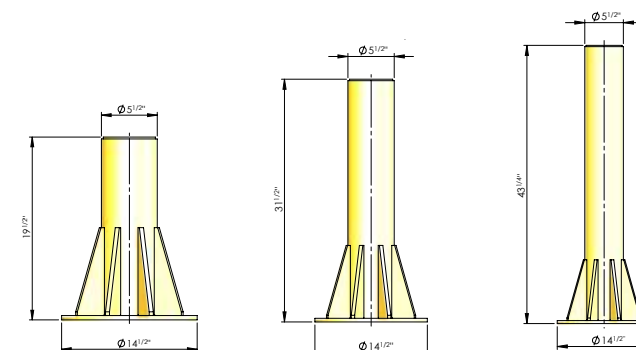

## **Contact Us**

### **REID Lifting**

7900 International Drive,  
Suite 300,  
Bloomington,  
MN 55425

-  +44 (0)1291 620 796
-  [info@reidlifting.com](mailto:info@reidlifting.com)
-  [us.reidlifting.com](http://us.reidlifting.com)

All information herein is copyright protected by REID Lifting Ltd. All company and product names are Trade Mark and Trade Name protected and all REID Product IPR is protected under Patents, Patents Pending and/or Design Rights.

 Printed using environment friendly processes and materials.