



3M™ Ultra-Lok™ Bracket

➤ Assembly & Operation Guide

Contents

Porta Gantry Rapide 1100	4
Porta Gantry Rapide 2200	6
Porta Gantry; S & M	8
Porta Gantry	10
T Davit	12
Porta Davit Quantum	14
Porta Davit Quantum Single Winch	16
Porta Davit Quantum Double Winch	18
Fitting device into Bracket (Gantries)	20
Fitting device into Bracket (Davits)	22



Lightweight. Portable. **Safe.**

Please read the following instructions and guidance notes carefully. These have been designed to aid users in carrying out the correct assembly of the bracket for each of our compatible lifting systems. Systems compatible with this product are:

- **PORTA**GANTRY^[R&IDE]
- **PORTA**GANTRY[®]
- **T**DAVIT[®]
- **PORTA**DAVIT^[QUANTUM]

➤ Assembly Instructions: PORTAGANTRY RAPIDE® 1100

The following instructions detail the assembly of the Ultra-Lok Bracket [US-RAWB003525] for the PORTAGANTRY RAPIDE, both Small and Medium frame types.

Appropriate PPE should be worn: ➤ Gloves ➤ Protective Footwear

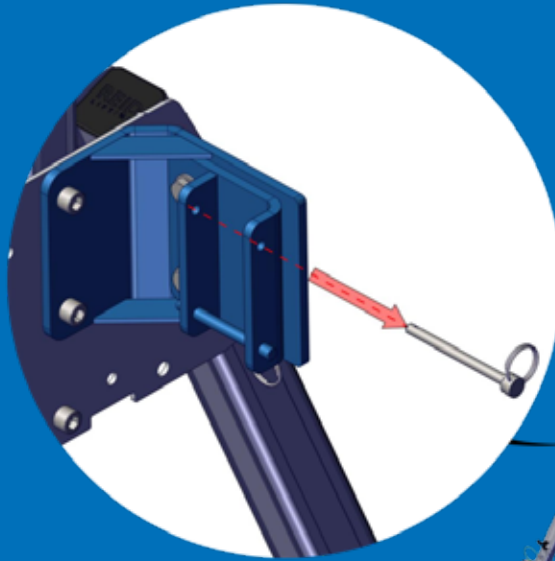

Assembling the PORTAGANTRY RAPIDE 1100: Ultra-Lok Bracket

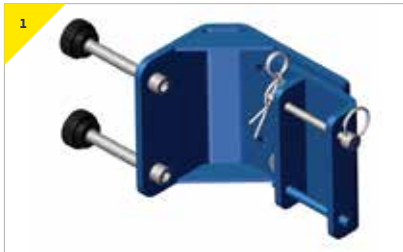

- › The bracket comes with the bolts supplied, as shown above.

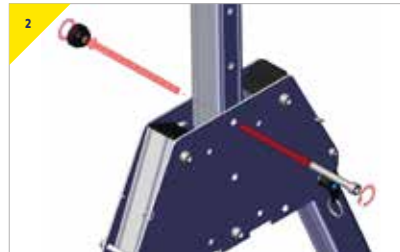

- › Remove the top bolt from the trap plate.

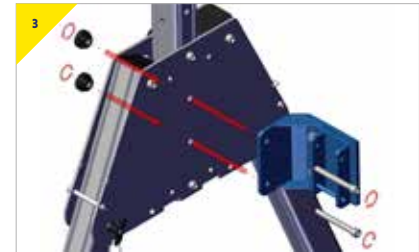

- › Present bracket to trap plate , insert and secure M12 bolt supplied with bracket.



- › Prepare bracket to receive the device; remove the pin supplied with the bracket.

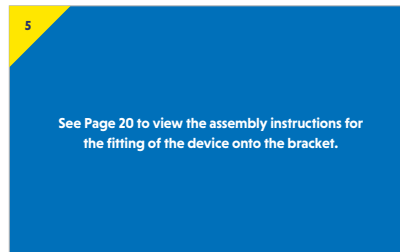

See Page 20 to view the assembly instructions for the fitting of the device onto the bracket.

➤ Assembly Instructions: PORTAGANTRY RAPIDE® 2200

The following instructions detail the assembly of the Ultra-Lok Bracket [US-RAWB003525] for the PORTAGANTRY RAPIDE, both Small and Medium frame types.

Appropriate PPE should be worn: ➤ Gloves ➤ Protective Footwear



Assembling the PORTAGANTRY RAPIDE 2200: Ultra-Lok Bracket

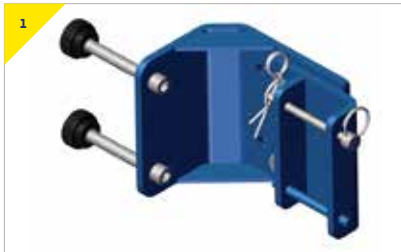

- The bracket comes with the bolts supplied, as shown above.

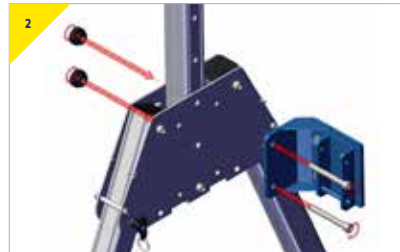

- Present bracket to trap plate as shown, use trap plate centre holes to insert and secure both M12 bolts that have been supplied with the bracket.



- Prepare bracket to receive the device; remove the pin supplied with the bracket.

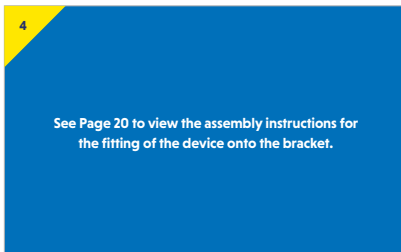

➤ Assembly Instructions: PORTAGANTRY®; S & M

The following instructions detail the assembly of the Ultra-Lok Bracket [US-RAWB003520] for the PORTAGANTRY, both Small and Medium frame types.

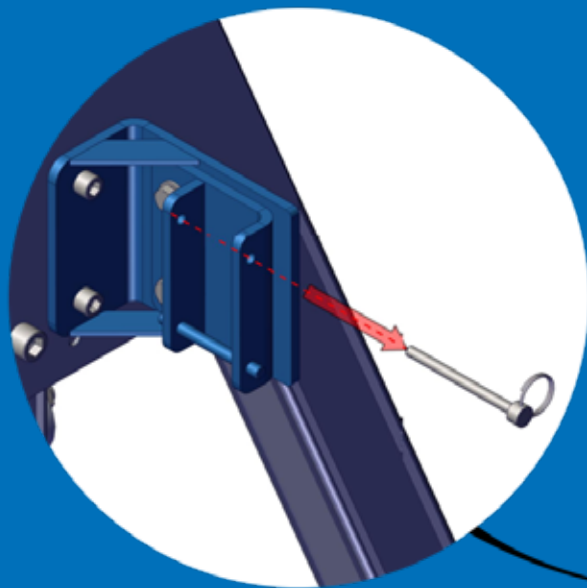

Appropriate PPE should be worn: ➤ Gloves ➤ Protective Footwear

Assembling the PORTAGANTRY Small and Medium: Ultra-Lok Bracket



- The bracket comes with the bolts supplied, as shown above.



- Present bracket to trap plate as shown, use trap plate centre holes to insert and secure both M12 bolts that have been supplied with the bracket.



- Prepare bracket to receive the device; remove the pin supplied with the bracket.

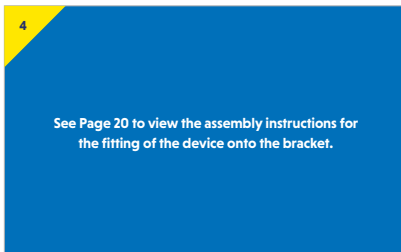

➤ Assembly Instructions: PORTAGANTRY®

The following instructions detail the assembly of the Ultra-Lok Bracket [US-RAWB003000] for the Davits & Gantry Winch Column.

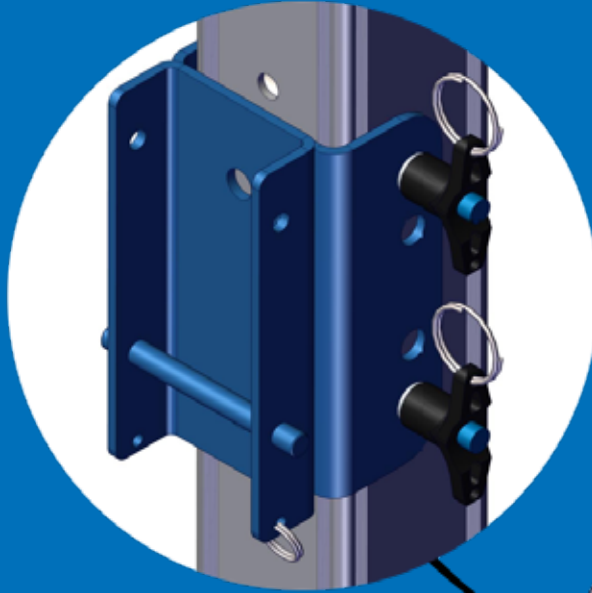

Appropriate PPE should be worn: ➤ **Gloves** ➤ **Protective Footwear**

Assembling the PORTAGANTRY Intermediate and above sizes: Ultra-Lok Bracket



- The bracket comes with the pins supplied, as shown above.

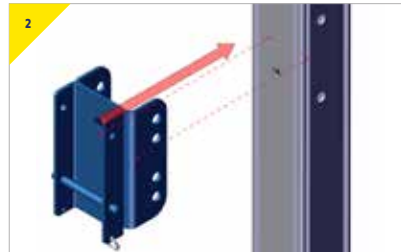

- Present the bracket to the winch column, ensuring that the correct holes line up ready to secure.

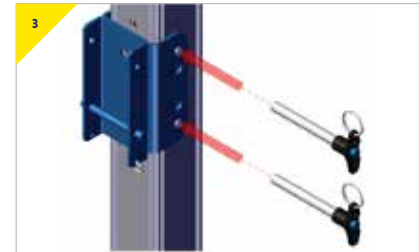

- Insert the pins that have been provided with the bracket.



- Bracket is ready to receive the device.

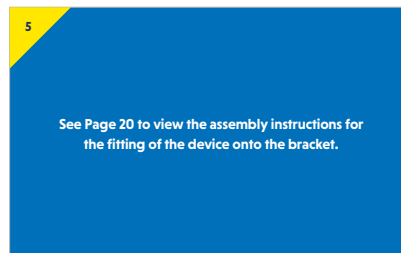

➤ Assembly Instructions: TDAVIT®

The following instructions detail the assembly of the Ultra-Lok Bracket [US-RAWB003000] for the Davits & Gantry Winch Column.

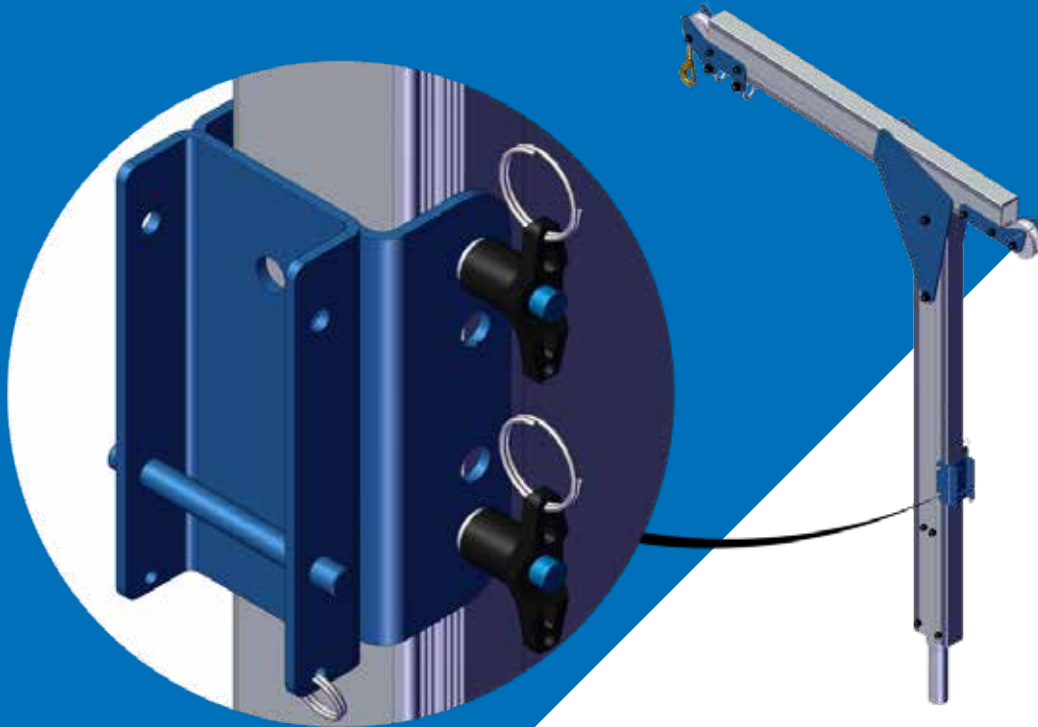

Appropriate PPE should be worn: ➤ **Gloves** ➤ **Protective Footwear**

Assembling the TDAVIT: Ultra-Lok Bracket



- › The bracket comes with the pins supplied, as shown above.

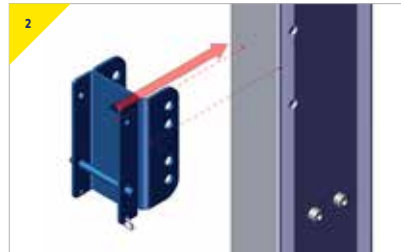

- › Present the bracket to the TDAVIT column, ensuring that the correct holes line up ready to secure.

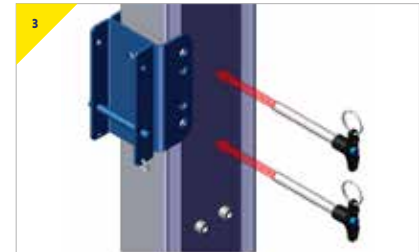

- › Insert the pins that have been provided with the bracket.



- › Bracket is ready to receive the device.

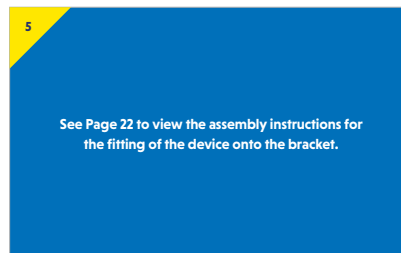

➤ Assembly Instructions: PORTADAVIT QUANTUM[®]

The following instructions detail the assembly of the Ultra-Lok Bracket [US-RAWB003000] for the Davits & Gantry Winch Column.



Appropriate PPE should be worn: ➤ **Gloves** ➤ **Protective Footwear**

For this configuration a sheave bracket column is required.
US-RAWB000095 – Sheave bracket PDQ column Medium sheave (4-7mm).

Assembling the PORTADAVIT [QUANTUM]: Ultra-Lok Bracket



- The bracket comes with the pins supplied, as shown above.

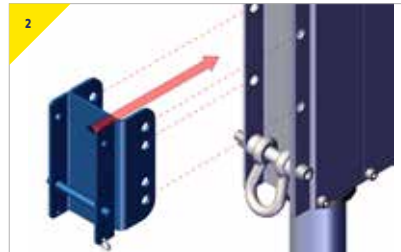

- Present the bracket to the column, ensuring that the correct holes line up ready to secure.

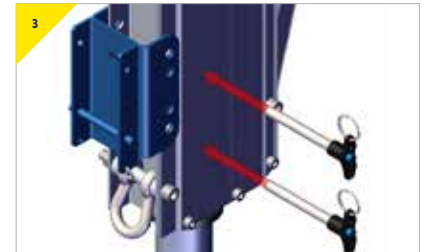

- Insert the pins that have been provided with the bracket.

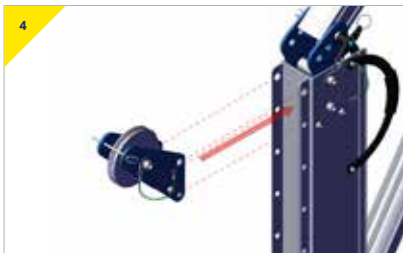

- Present the sheave bracket to the top of the column.

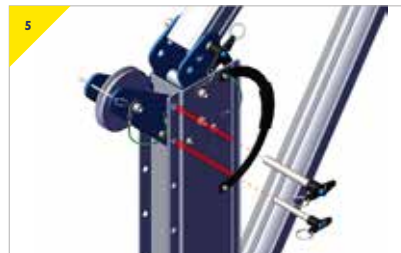

- Insert the pins that have been provided to secure the sheave.



- Bracket is ready to receive the device.

> Assembly Instructions: PORTADAVIT QUANTUM®

The following instructions detail the assembly of the Ultra-Lok Bracket [US-RAWB003006] for the Davits & Gantry Winch Column.



Appropriate PPE should be worn: > Gloves > Protective Footwear

Assembling the PORTADAVIT QUANTUM Backstay (Single Winch): Ultra-Lok Bracket



1 The bracket comes with the pins supplied, as shown above.

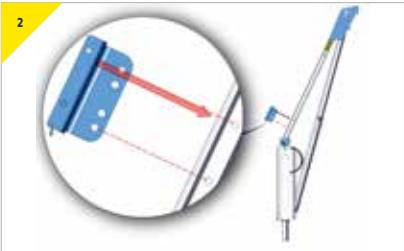

2 Present the bracket to the backstay, ensuring that the correct holes line up ready to secure.

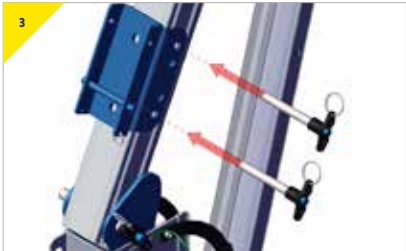

3 Insert the pins that have been provided with the bracket.

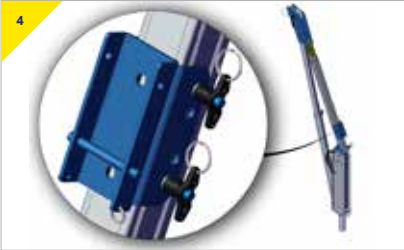

4 Bracket is ready to receive the device.

5 See Page 22 to view the assembly instructions for the fitting of the device onto the bracket.

➤ Assembly Instructions: PORTADAVIT QUANTUM®

The following instructions detail the assembly of the Ultra-Lok Bracket [US-RAWB003010] for the PORTADAVIT QUANTUM Backstay (Double Winch).



Appropriate PPE should be worn: ➤ Gloves ➤ Protective Footwear

Assembling the PORTADAVIT QUANTUM Backstay (Double Winch): Ultra-Lok Bracket



- › The bracket comes with the pins supplied, as shown above.

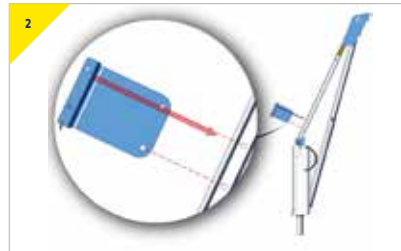

- › Present the bracket to the backstay, ensuring that the correct holes line up ready to secure.



- › Insert the pins that have been provided with the bracket.

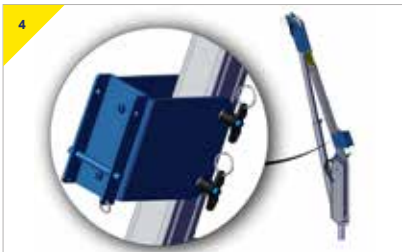

- › Bracket is ready to receive the device.

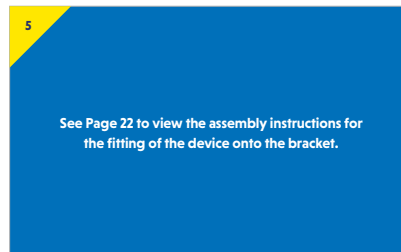

➤ **Assembly Instructions:** Fitting the device (Gantries)

The following instructions detail the assembly of the device being attached into the Ultra-Lok bracket on all Gantries.



Appropriate PPE should be worn: ➤ **Gloves** ➤ **Protective Footwear**

Fitting the device into the Ultra-Lok Bracket



- Present the device onto the bracket.



- Insert the pin supplied with the bracket as shown to secure the device.



- Insert the pin provided the secure the pin in place.



- Device is now secure and ready to use.

➤ **Assembly Instructions:** Fitting the device (Davits)

The following instructions detail the assembly of the device being attached into the Ultra-Lok bracket on all Davits.



Appropriate PPE should be worn: ➤ **Gloves** ➤ **Protective Footwear**

Fitting the device into the Ultra-Lok Bracket

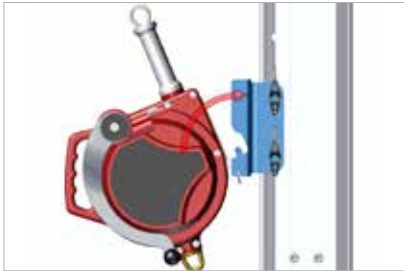

- Present the device onto the bracket.

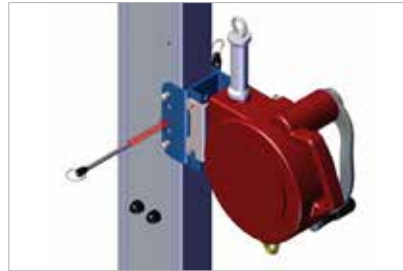

- Insert the pin supplied with the bracket as shown to secure the device in place.



- Device is now secure and ready to use.

Contact Us

REID Lifting Inc, USA

7900 International Drive,
Suite 300,
Bloomington,
MN 55425
USA

-  +1(888)-721-6411
-  info@reidlifting.com
-  us.reidlifting.com

All information herein is copyright protected by REID Lifting Ltd. All company and product names are Trade Mark and Trade Name protected and all REID Lifting Ltd. Product IPR is protected under Patents, Patents Pending and/or Design Rights.

 Printed using environment friendly processes and materials.